



Department of Energy, Mines,  
Industry Regulation and Safety



# Rules for Pools and Spas

A guide to the requirements  
for safety barriers in  
Western Australia



July 2024

## Referenced documents

### Australian Building Codes Board, Canberra, ACT

- Building Code of Australia – Volumes One and Two of the National Construction Code.

### Standards Australia International Ltd, Sydney, NSW

- Australian Standard AS 1926.1-2012 – Swimming pool safety – Safety barriers for swimming pools.
- Australian Standard AS 1926.1:2012 Rul 1:2021 – Ruling to AS 1926.1 Swimming pool safety – Safety barriers for swimming pools.
- Australian Standard AS 1926.2-2007 – Swimming pool safety – Location of safety barriers for swimming pools (incorporating amendments 1 and 2).
- Australian Standard AS 1926.1-1993 – Swimming pool safety, Part 1: Fencing for swimming pools (incorporating amendment 1).
- Australian Standard AS 1288-2006/2021 – Glass in buildings – Selection and installation.
- Australian/New Zealand Standard AS/NZS 2208:1996 – Safety glazing materials in buildings.
- Australian/New Zealand Standard AS/NZS 1170.2:2021 – Structural Design Actions – Wind actions.

Reproduced by the Building and Energy Division of the Department of Energy, Mines, Industry Regulation and Safety/ABN 69 410 335 356 with the permission of Standards Australia Limited under licence CLF0823dom.

Copyright in AS 1926.1-2012; AS 1926.2-2007; AS 1926.1-1993; AS 1288-2021; AS/NZS 2208:1996; AS/NZS 1170.2:2021 vests in Standards Australia and Standards New Zealand. Users must not copy or reuse this work without the permission of Standards Australia or the copyright owner.

## Disclaimer

The information contained in this publication is provided as general information and a guide only. It should not be relied upon as legal advice or as an accurate statement of the relevant legislation provisions. If you are uncertain as to your legal obligations, you should obtain independent legal advice.

# Contents

<b>Section 1: Introduction</b> .....	<b>2</b>
<b>Section 2: New swimming and spa pools</b> .....	<b>4</b>
<b>Section 3: Safety barrier requirements</b> .....	<b>8</b>
<b>Section 4: Additional considerations</b> .....	<b>36</b>
<b>Section 5: Frequently asked questions</b> .....	<b>39</b>
<b>Section 6: Resources</b> .....	<b>43</b>
<b>Appendix A: Building Code compliance</b> .....	<b>44</b>
<b>Appendix B: Overview of responsibilities</b> .....	<b>45</b>



# Section 1: Introduction

This publication is intended as **general guidance**, primarily for owners and occupiers, on the safety barrier requirements for swimming and spa pools in Western Australia within the:

- Building Regulations 2012 (the Regulations);
- Building Code of Australia, being the Volumes One and Two of the National Construction Code (Building Code); and
- relevant referenced Australian Standards.

It is not appropriate to rely on this publication as legal advice or for the purpose of demonstrating compliance or non-compliance with the pool safety laws.

*Rules for Pools and Spas* was initially developed following a report tabled in the Western Australian Parliament in 2002 by the Standing Committee on Environment and Public Affairs in relation to “Swimming Pool Fencing” which, among other things, recommended a user-friendly guide on the requirements in the Regulations and relevant Australian Standards.

This edition of *Rules for Pools and Spas* replaces the previous 2016 edition. It introduces a new format that outlines one set of rules applicable to all swimming and spa pools and, where relevant, specific alternatives for older swimming and spa pools (pre-May 2016 and pre-November 2001).

Legislation that mandates the installation of safety barriers is intended to protect children under the age of five (young children) by restricting their access to the area containing the swimming or spa pool.

Safety barriers form part of a broad strategy, to prevent and reduce deaths of young children by drowning, that primarily relies upon adult supervision. Other important elements include public education, safety barrier inspections, water familiarisation, cardiopulmonary resuscitation (CPR) and first aid.

## Statistics

Drowning is a leading cause of accidental death for young children.

For Western Australia, in the 10-year period between July 2012 and June 2022, there were 19 fatal drowning incidents and 174 non-fatal drownings recorded for young children in swimming and spa pools. Reference: [RLSSWA Drowning Report 2022](#).

The percentage of young children who have died by drowning in swimming and spa pools has reduced over time. This has been largely attributed to the introduction of safety barrier requirements and community education initiatives.

From January 1988 to December 1996 there was an average of 4.9 drowning deaths per year, whereas from July 2012 to June 2022 there was an average of 1.9 drowning deaths per year. The difference between average drowning deaths is more significant when the increase of both the population and number of swimming and spa pools is considered.

## What is a swimming or spa pool?

For the purposes of this publication, swimming and spa pool means:

Any excavation or structure containing water and principally used, or that is designed, manufactured or adapted to be principally used, for swimming, wading, paddling, or the like, including a wading pool or spa pool, which has the capacity to contain water that is more than 30cm deep and is associated with:

- a) a Class 1a building; or
- b) less than 30 sole-occupancy units in a Class 2 building; or
- c) a Class 4 part of a building.

**Class 1a** – single dwelling such as a detached house, row house, terrace house, town house or villa unit.

**Class 2** – building containing two or more separate dwellings such as apartments.

**Class 4** – a part of a building that is a sole dwelling or residence within a building of a non-residential nature such as a caretaker's residence connected to a shop or office.

Information on building classifications can be found in the Building Code which is freely available from the [Australian Building Codes Board \(ABCB\)](#).

Swimming and spa pools include above-ground, in-ground, and portable swimming and spa pools, but not spa baths. A spa bath is typically located within a bathroom and only filled immediately prior to being used then drained after each use.

Swimming and spa pools that are not covered by the above (such as public swimming pools) are generally controlled under the [Health \(Aquatic Facilities\) Regulations 2007](#). More information can be found in the [Code of practice for the design, operation, management and maintenance of aquatic facilities](#) available from the Department of Health (WA).

## When do you need a safety barrier?

**All swimming and spa pools that have a depth of water of more than 30cm require safety barriers** that comply with the technical requirements (see Section 3) to restrict access by young children. This includes temporary and portable swimming and spa pools.

Failure to provide a compliant safety barrier risks the lives of young children and may lead to significant fines.

Adults should never wholly rely on safety barriers as they are only intended to **restrict** access by young children, not prevent access, and are secondary to supervision.

## Section 2: New swimming and spa pools

### Before construction

To avoid delays and other regulatory compliance problems, owners are encouraged to consider the following well before construction or installation of the pool has commenced:

#### Safety barrier

It is important to organise a safety barrier as soon as possible because swimming and spa pools are often installed shortly after the building permit has been granted and it may take some time to have the safety barrier supplied and installed.

Remember: there must be a compliant safety barrier in place once the pool is complete and contains water that is more than 30cm deep.

#### Location of pool

Where possible, the swimming or spa pool should be located in an area with clear views from commonly used areas of the house or garden. This makes it easier to keep an eye on young children who may be trying to access the pool area without an adult.

#### Location of other structures

While not mandatory, structures that are frequently accessed, such as sheds, garages, barbeques, clotheslines, and the like, are best located outside of the swimming or spa pool area. This reduces the likelihood of self-closing gates being propped open to gain access to those structures.

### Boundary (or dividing) fences

Using a boundary fence as part of a safety barrier to a swimming or spa pool may present some challenges. For example, the height and non-climbable zone requirements can be difficult to comply with and any subsequent modifications to the fence will need prior permission from the adjoining property owner(s).

See Section 3 for the technical requirements which includes two compliance options for owners who choose to use their boundary fence as part of the safety barrier.

### Guidance from local government

Local government inspectors are experienced in pool safety barrier compliance and many local governments offer a pre-construction on-site consultation service.

Speaking to the local government pool inspectors can help to avoid non-compliance.

## Building approvals

Swimming and spa pools (including above-ground and portable types) must have a building permit in effect prior to their construction or installation.

Pool fences are generally not required to have a building permit in effect prior to installation. A building permit is only required where a pool fence:

- also acts as a fall protection barrier (balustrade) required by the Building Code where people could fall 1m or more; or
- is constructed of masonry and over 0.75m in height\*; or
- is constructed of a material other than masonry and over 1.8m in height\*; or
- is located in cyclonic wind region C or D (as detailed in AS/NZS 1170.2, as referenced in the Building Code)\*.

\* Unless constructed in accordance with a [relevant local government local law](#).

A building permit is not required where the swimming or spa pool or safety barrier:

- is to remain erected for less than one month; or
- is to be located in certain regional areas where a building permit is not required.

Anyone can apply for a building permit – typically this will be the pool builder, but it can also be the owner or the safety barrier installer.

The person named as the builder on the building permit takes the responsibility for compliance with the *Building Act 2011* and the Regulations.

For specific advice on building permit requirements please refer to your local government.

## During construction

Effective supervision is crucial during the construction of a swimming pool due to the increased risk of drowning for young children during this phase.

Tragically, many young children have drowned in pools under construction where the site was not secure, for example, where a temporary fence panel had been propped open.

## Site safety

Construction sites come under the jurisdiction of WorkSafe and are subject to the requirements under the *Work Health and Safety Act 2020* (WHS legislation).

During construction of the swimming pool, the pool builder is required under WHS legislation to protect people from harm to their health, safety and welfare as far as practicable. This includes ensuring that the construction site is secure from unauthorised access, such as that of young children. This is generally achieved by using construction barriers (temporary fences), signage, and supervision.

The requirements under WHS legislation apply for the duration that the pool builder is in control of the site, usually from the commencement of the excavation through to the completion of the contract for the building work which, for a swimming pool, is typically handover.

If an owner thinks the construction barrier is unsafe or has any concerns, they should discuss this with the pool builder immediately. There are significant penalties under WHS legislation for non-compliance.

The above guidance presumes the pool builder to be the “person conducting a business or undertaking” under the WHS legislation.

Complaints about the safety and security of the swimming pool during construction should be directed to WorkSafe (1300 307 877) and the relevant local government.

## Section 2: New swimming and spa pools

### On completion

On completion (generally at handover) of a new swimming or spa pool, the person named as the **builder** on the building permit (generally the pool installer) must ensure that:

- a compliant safety barrier has been provided if the depth of water is more than 30cm (there are no exceptions to this requirement);
- the swimming or spa pool and the safety barrier (which may be temporary) comply with the building permit and the applicable building standards; and
- a BA7 Notice of Completion (Notice) is submitted to the local government within seven days of completion of the building work for the swimming or spa pool.

Penalties for failure to submit a Notice within seven days of completion of building work include:

- infringement notice of \$500; or
- prosecution resulting in a criminal conviction and court-imposed penalty of up to \$10,000 plus costs.

### After completion

On and after completion of a new swimming or spa pool, **owners and occupiers** must ensure that the safety barrier (temporary or long-term) remains compliant.

### Safety barrier compliance documents

Owners of new swimming or spa pools should prepare for the initial inspection of the safety barrier by obtaining compliance documents from the installer of the long-term safety barrier. The local government inspector will typically require a copy of these documents during the initial inspection:

- AS 1926.1 Section 3 compliance reports; and
- for glass fence panels a certificate from the installer that includes:
  - company name, contact phone number and email address;
  - date and address of installation;
  - description of works covered by this certificate;
  - confirmation the glass is Grade A safety glass;
  - name, qualifications, and experience of the person signing the certificate; and
  - verification the glass pool fence system complies with:
    - AS 1288 and AS/NZS 2208; and/or
    - a local government approved performance solution.





### Initial inspection

Once the construction of the swimming or spa pool is completed and it has a depth of water exceeding 30cm, the owner should immediately contact the local government to organise an inspection of the safety barrier.

Local governments are required to inspect the safety barrier whether it is a temporary or long-term installation.

During the initial inspection, the local government will collect the compliance documentation detailed in the previous page for the long-term safety barrier. Without this documentation the local government may not be able to determine compliance. The local government may request additional compliance documentation in certain circumstances. Compliance documentation should have been provided to the owner by the supplier/installer of the long-term safety barrier at installation.

Temporary safety barriers do not typically require compliance documentation due to their short-term nature, however, must comply with the safety barrier requirements.

A local government can charge the owner for an initial inspection. This charge includes any subsequent reinspection's in the event of non-compliance.

Owners of private swimming pools should be diligent in their selection of safety barrier suppliers and installers to ensure the work carried out has suitable documentary evidence of compliance. Where a safety barrier supplier/installer is unable to demonstrate compliance, the local government's inspector may be unable to determine the safety barrier as compliant. Where this occurs, owners are encouraged to seek assistance from [Consumer Protection](#). Depending on the circumstances, a [building service complaint](#) may also be able to be lodged.

### Periodic inspections

The local government will inspect the safety barrier of a swimming or spa pool at intervals not exceeding four years to ensure it remains compliant and is being maintained. The local government will typically contact the property owner beforehand to organise the inspection. Some remote areas of the State are excluded from these requirements.

The local government can charge the owner for carrying out its periodic inspection program. This is typically an annual charge.

## Section 3: Safety barrier requirements

This section is intended as general guidance on the application of:







- the Building Code deemed-to-satisfy pathway for the performance requirement “Swimming pool access” only (AS 1926.1-2012 and AS 1926.2-2007); and
- AS 1926.1-1993 (as an alternative compliance pathway) for swimming and spa pools applied for, or installed, prior to 1 May 2016 and 5 November 2001 for components that would not otherwise comply with AS 1926.1-2012.

This section should be read in conjunction with the Regulations, Building Code, and relevant Australian Standards. It is applicable to safety barriers for all private swimming and spa pools with a depth of water of more than 30cm, regardless of age, unless otherwise specifically noted.

### Safety barrier location requirements

A swimming or spa pool is required to have a safety barrier that restricts access from the street, adjoining properties and all buildings other than Class 10 buildings (private garage, carport and shed or the like). The examples on the next two pages illustrate a variety of configurations for safety barriers.

#### Legend

-  Gate complying with AS 1926.1
-  Child-resistant doorset complying with AS 1926.1
-  Child-resistant openable window complying with AS 1926.1
-  Openable window not complying with AS 1926.1
-  Sliding door not complying with AS 1926.1
-  Fence, retaining wall or other such barrier complying with AS 1926.1
-  Wall of dwelling with no openings

#### Example 1

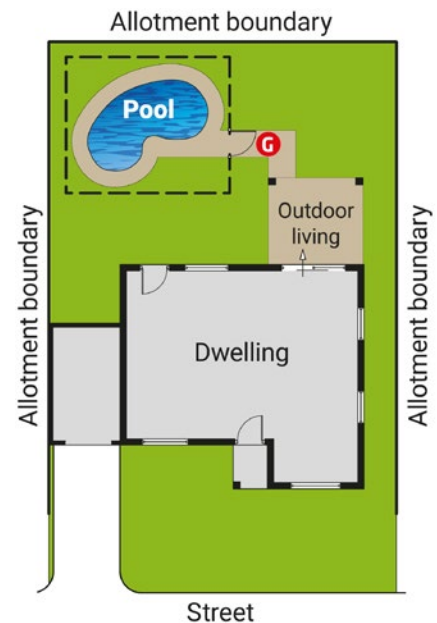

#### Example 2

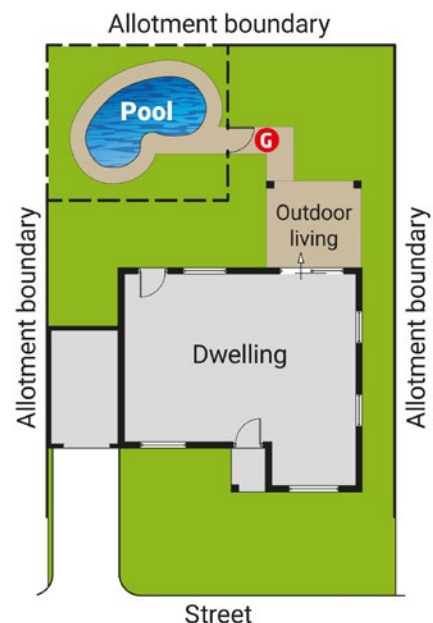

Section 3: Safety barrier requirements

Example 3

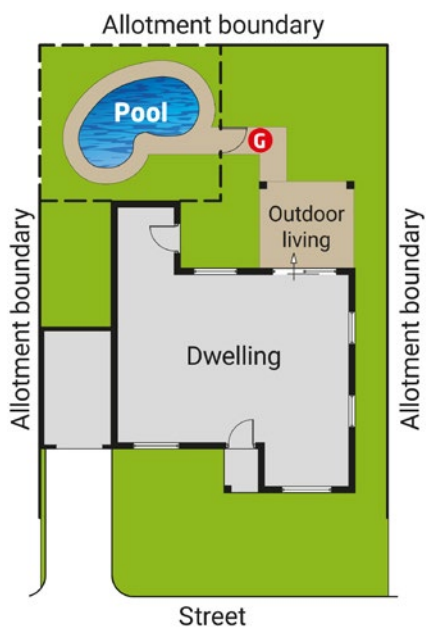

Child-resistant doors can be used as part of a safety barrier to an indoor swimming or spa pool, or the indoor portion of an indoor/outdoor swimming or spa pool.

Example 5

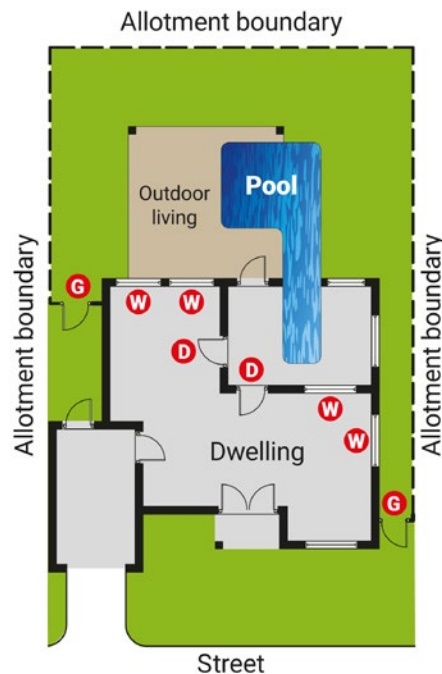

Child-resistant doors are only permitted to be used as part of a safety barrier to an outdoor swimming or spa pool where a performance solution has been approved by the local government or where the pool is a pre-November 2001 pool.

Example 4



Example 6

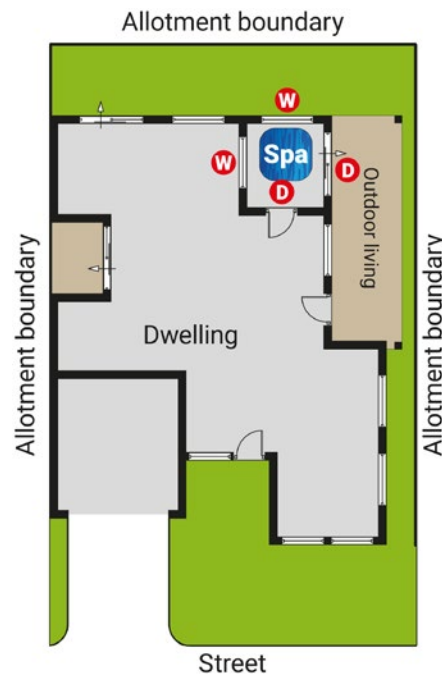

**Section 3: Safety barrier requirements**

**Class 10 buildings**

A Class 10 building is a non-habitable building such as a private garage, carport, shed, or the like.

Access to the swimming or spa pool does not need to be restricted from a Class 10 building where it is located wholly within the safety barrier (Example 7). However, where a Class 10 building forms part of the safety barrier, access needs to be restricted to prevent access through it (Example 8).

**Example 7**

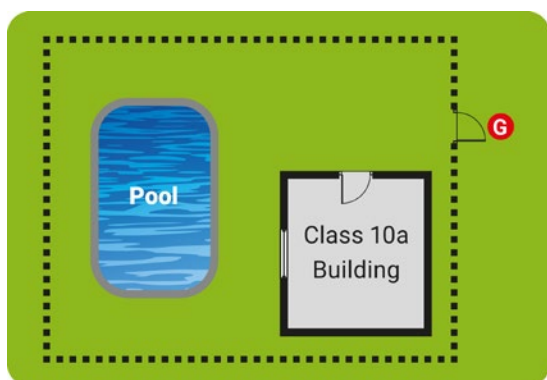

The Class 10 building is wholly within the pool area and does not provide access to the pool through the safety barrier. As the building is not habitable, access between it and the pool does not need to be restricted.

**Example 8**

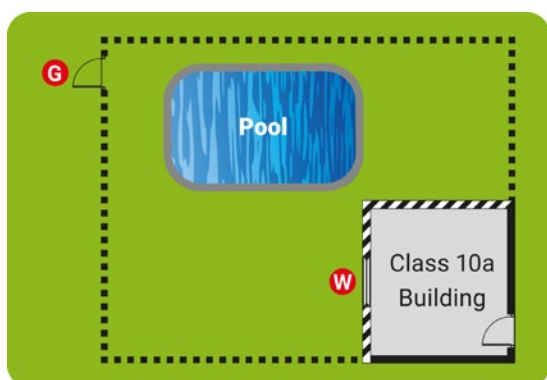

The Class 10 building forms part of the safety barrier. The openable portion of the window must be child-resistant, otherwise the Class 10 building provides access into the pool area through that window. The door does not form part of, and is not generally permitted to be part of, the safety barrier and as such does not need to be restricted.

## Safety barrier design and construction

Please note that all dimensions provided are maximum or minimum values. There is no additional tolerance.

### General

A safety barrier may be made of any material providing it is durable and complies with the requirements contained within AS 1926.1-2012 including the loading requirements.

Be wary of using untested safety barrier systems or components as they may not have supporting documentation that demonstrates compliance.

A safety barrier must:

- have a minimum height of 1.2m on the non-poolside;
- be designed with the intention of restricting access by children under the age of five;

- be permanently fixed (unable to be removed without the use of tools); and
- be designed to be vertical, must not lean towards the swimming or spa pool, and must not lean away from the swimming or spa pool by more than 15 degrees.

Safety barriers should have no sharp edges or projections that may cause injury.

Safety barriers, other than boundary barriers (boundary fence), that have a height of 1.8m or greater can be climbable on both sides, unless intersecting with another safety barrier with a non-climbable zone (see "Intersecting safety barriers").

Safety barrier height is measured perpendicularly to the finished ground level.



### Section 3: Safety barrier requirements

#### Non-climbable zones

A non-climbable zone (NCZ) is a zone on a safety barrier, and/or in the space adjacent to a safety barrier, that is intended to restrict climbing by young children.

NCZs apply to:

- safety barriers that have a height of less than 1.8m; and
- boundary barriers.

NCZs do not apply to:

- safety barriers that have a height of 1.8m or greater (except boundary barriers).

NCZs must be continuous for the length of the safety barrier. There must be no objects, plants, handholds, or footholds located within a NCZ that facilitate climbing, including safety barrier components, surface projections and indentations with a horizontal depth of more than 10mm.

**Note:** A plant does not facilitate climbing if it does not act as a foothold or handhold.

There are five NCZs that apply to a safety barrier.

#### NCZ 1

NCZ 1 is a 900mm measurement (typically vertical but can be on angle for sloping panels and similar circumstances) that can be located anywhere on the face of the safety barrier between horizontal components or handholds and footholds (see Diagram 1).

**Note:** NCZ 1 does not apply to a boundary barrier using the poolside option.

#### Diagram 1

Dimensions in millimetres

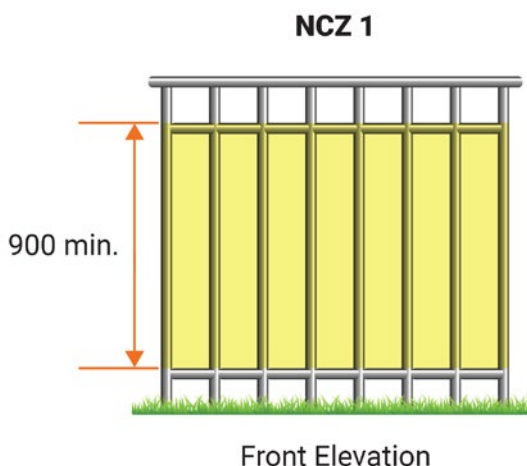
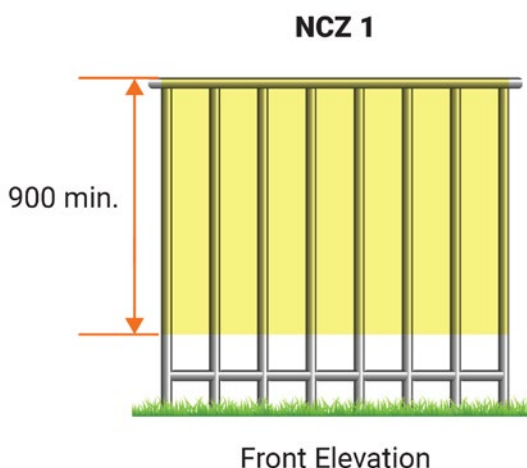

### NCZ 2

NCZ 2 is a 900mm quadrant that is aligned with NCZ 1 and extends away and downwards from the safety barrier and the pool area (see Diagram 2).

**Note:** NCZ 2 does not apply to a boundary barrier using the poolside option.

### NCZ 3

NCZ 3 is a 900mm quadrant that starts at the top of the safety barrier and extends away and upwards from the safety barrier and the pool area. Additionally, it extends down to the top of NCZ 1 and 2 (see Diagram 3).

**Note:** NCZ 3 does not apply to a boundary barrier using the poolside option.

Diagram 2

Dimensions in millimetres

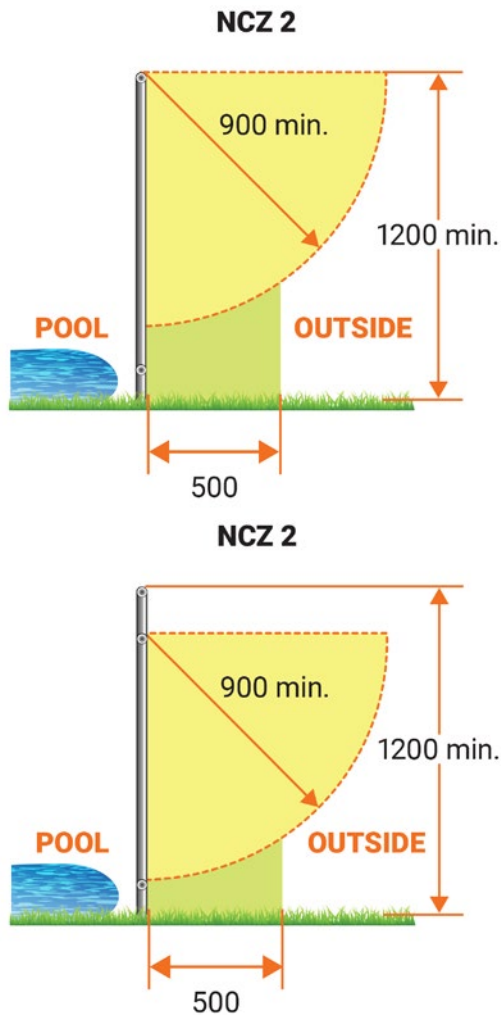
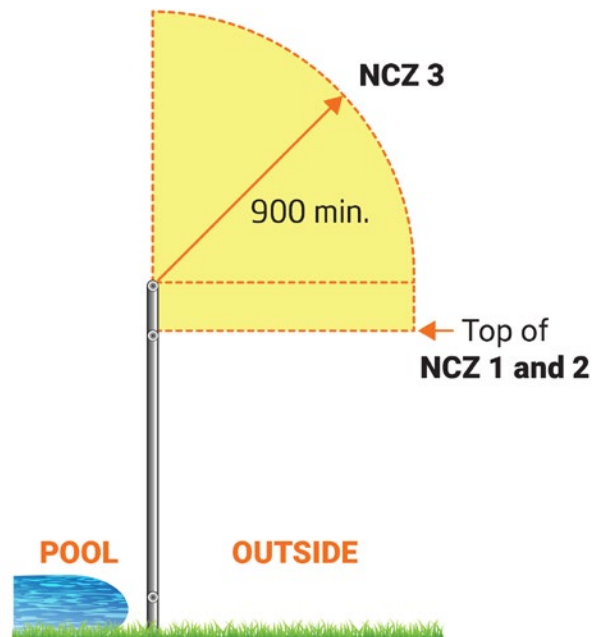

Diagram 3

Dimensions in millimetres



No climbable objects within 500mm of the pool fence.

Section 3: Safety barrier requirements

NCZ 4

NCZ 4 is a 900mm high x 300mm deep area located on the poolside of the safety barrier, aligning with NCZ 1. It is only required where the safety barrier has openings between vertical members that exceed 10mm (see Diagram 4).

Where the gap between vertical members is 10mm or less, climbable objects, including horizontal components, are permitted if they are located on the poolside of the safety barrier.

This requirement is intended to make it difficult for a child to put their foot through an open style safety barrier and use an object or surface on the poolside as a foothold to facilitate climbing.

**Note:** NCZ 4 does not apply to a boundary barrier using the poolside option.

Diagram 4

Dimensions in millimetres

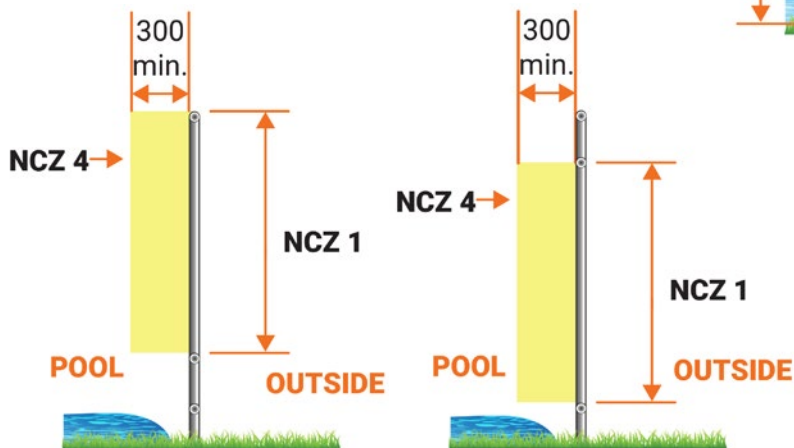

NCZ 5

NCZ 5 is only applicable to boundary barriers using the poolside option. It is a 900mm lower quadrant that starts at the top of the boundary fence and extends into the pool area (see Diagram 5).

**Note:** NCZ 5 does not apply to a boundary barrier using the non-poolside option.

Diagram 5

Dimensions in millimetres

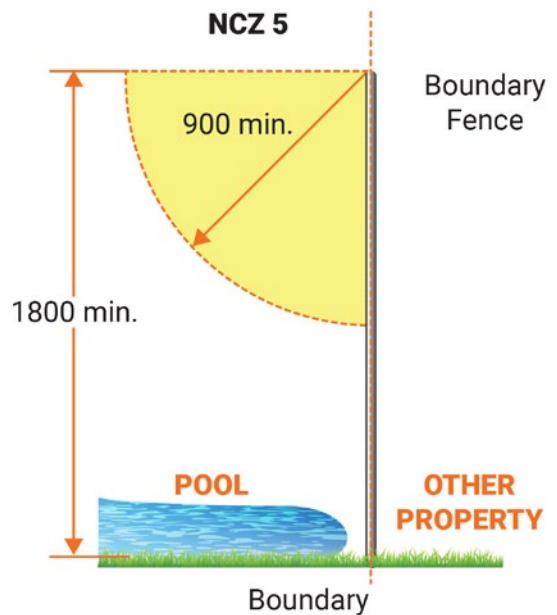



### Sloping or stepped safety barriers

Where safety barriers may be sloping or stepped, the NCZ must be maintained (see Diagram 6)

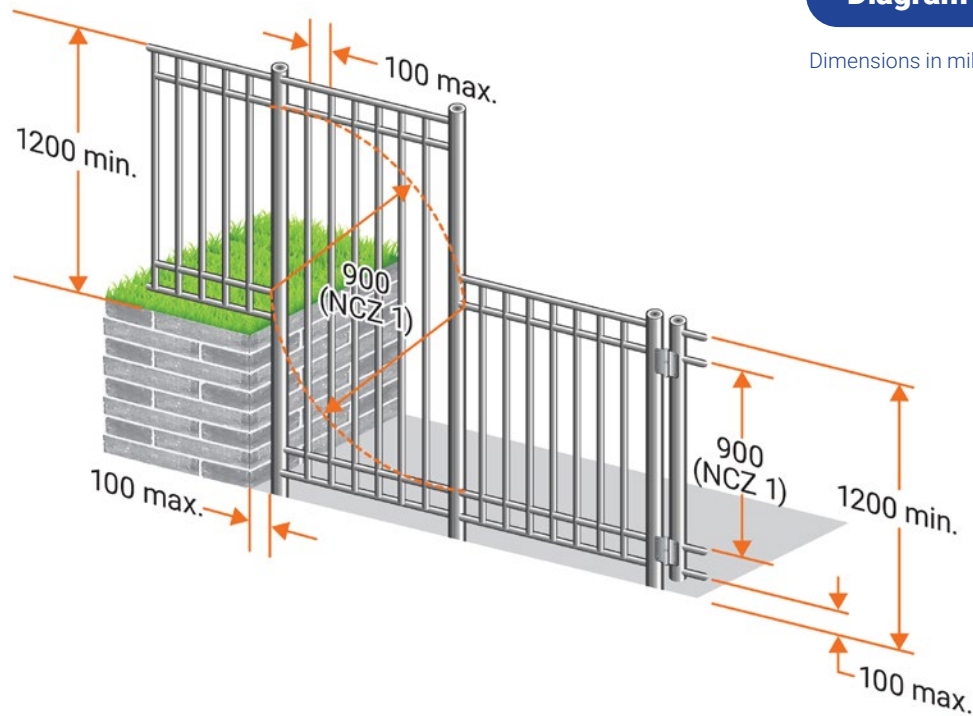

Diagram 6

Dimensions in millimetres

### Modifying horizontal surfaces in a NCZ

Horizontal members that are located within a NCZ and are considered to facilitate climbing are not permitted unless a 60-degree wedge/chamfer has been fixed to the top of the horizontal surface.

This generally only applies where the vertical surface behind is solid (has no horizontal gaps) or has vertical members spaced no more than 10mm apart (see Diagram 7).

The 60-degree wedge/chamfer needs to be flush with the vertical surface behind, creating a sloping surface that is difficult for a child's foot to rest on.

Diagram 7

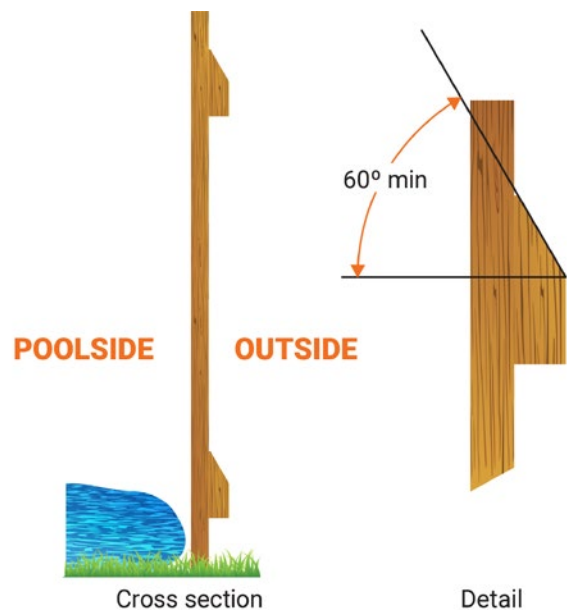

Section 3: Safety barrier requirements

Intersecting safety barriers

Where a safety barrier intersects with another safety barrier, the NCZs 1 and 2 continue past the intersection by 900mm, even if the intersecting safety barrier exceeds 1.8m in height (see Diagram 8).

Diagram 8

Dimensions in millimetres

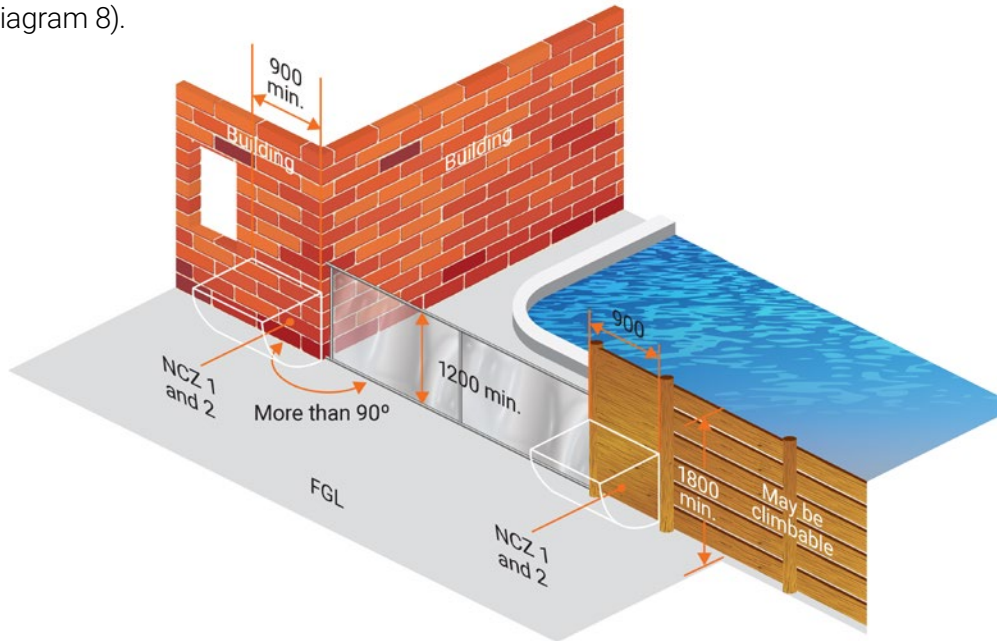

Vertical member gap sizes

The maximum horizontal gap between vertical members within a safety barrier is 100mm.

Diagram 9

Dimensions in millimetres

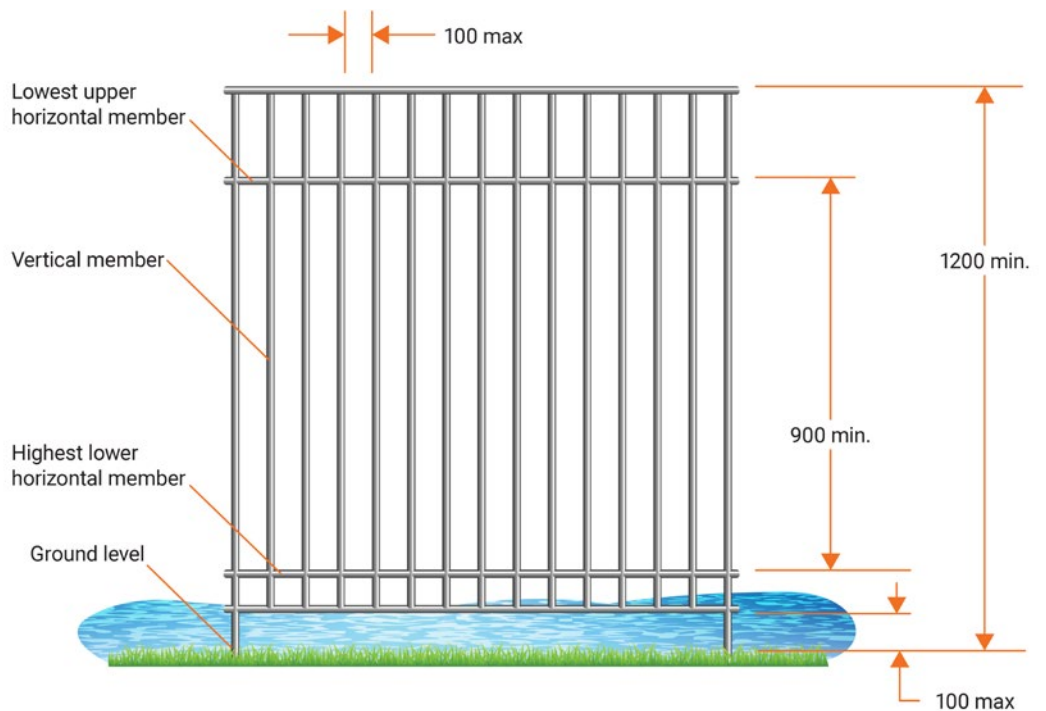

### Stabilised ground surface

The maximum gap between the safety barrier and the stabilised ground surface beneath is 100mm.

The surface directly beneath the safety barrier must be stable and not easily removed or eroded by weather, children, or animals.

Suitable materials may include pavers, concrete, and decking.

### Glass fences

Fences that incorporate glass must comply with AS 1926.1-2012, and AS 1288 for the selection of glass. The glass must be Grade-A safety glass.

### Features and objects near a safety barrier

Objects, steps, retaining walls or ground level changes that reduce the minimum height of the safety barrier required on that side must not be within 500mm of the safety barrier.

**Note:** Does not apply to a boundary barrier using the poolside option.

Diagram 10 shows a compliant outcome with nothing in the NCZs that will facilitate climbing and nothing within 500mm that will reduce the height of the fence.

Diagram 11 shows a non-compliant outcome with a retaining wall located within the 500mm area.

Diagram 10

Dimensions in millimetres

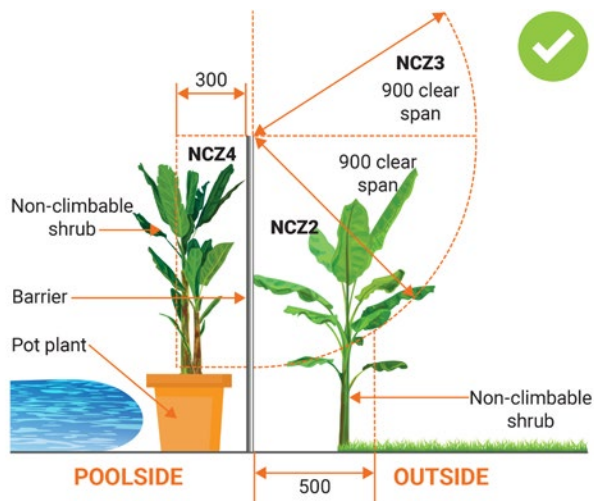
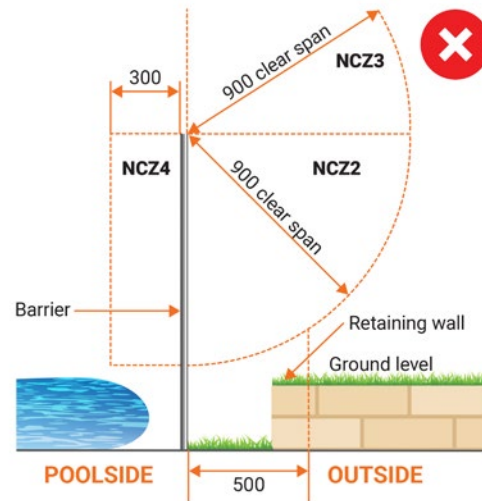

Diagram 11

Dimensions in millimetres



## Section 3: Safety barrier requirements

### Perforated material or mesh

A safety barrier that uses mesh or other perforated material (rather than vertical uprights or solid infill panels) and has holes or gaps that exceed 13mm but are not more than 100mm, must have a height of at least 1.8m from the finished ground surface.

Should gaps be 13mm or less, the safety barrier may have a height as low as 1.2m.

This type of safety barrier must be sufficiently stable so that under application of force:

- its height shall not drop to less than 1.2m when a 25kg weight is placed at any point along the top of the safety barrier; and
- the vertical gap between the bottom of the safety barrier and the stabilised ground surface shall not exceed 100mm when an upward force of 100N (approximately 10kg) is applied at any point along the bottom of the safety barrier.

**Note:** To satisfy these requirements, it is generally necessary for safety barriers that use mesh or other perforated material to include a strainer wire or rail at the top and bottom.

**Note:** Gap sizes are measured horizontally across the widest part.

### Boundary barriers

A boundary barrier is located between two adjoining properties and is typically a dividing fence. This includes, but is not limited to, a barrier between the pool area and:

- an adjoining privately owned property;
- the verge;
- road;
- lane or right of way;
- crown land; and
- public park.

While a boundary barrier is most often a boundary (dividing) fence, it may include a wall of a building or retaining wall.

Boundary fences are typically of joint ownership between the adjoining properties. Consultation with the adjoining property owner is strongly advised prior to any modification of the boundary fence.

If a barrier is setback 900mm from the boundary, the barrier may be considered an internal barrier rather than a boundary barrier.

Where boundary barriers are used to form part of the safety barrier, there are two options available, the poolside option and the non-poolside option.

### Boundary barriers – Poolside option

The poolside option is the preferred choice in most circumstances as compliance of the boundary barrier is wholly within the control of the pool owner.

The boundary barrier must be at least 1.8m high on the poolside when measured from the finished ground level directly abutting the base of the boundary barrier.

There must be no objects, components or surfaces that will facilitate climbing within a 900mm quadrant, measured from the top of the boundary barrier, and extending away and downwards on the poolside (known as NCZ 5). This includes the face of the boundary barrier itself. The portion of the boundary barrier located underneath NCZ 5 may be climbable, but the height from the finished ground level must be maintained.

The non-poolside of the boundary barrier (the adjoining property's side) is generally not within the control of the pool owner and may be less than 1.8m high and be climbable.

**Note:** NCZ 5 applies from the top of the fence, including any extensions. Where an existing fence is less than 1.8m high, and the fence height is extended to meet the 1.8m height requirement, the NCZ 5 applies from the top of the extension. Depending on the fence material, this can pose a problem as the extension may have gaps, spaces, or joints inside the NCZ 5 that may facilitate climbing, rendering it non-compliant.

### Diagram 12

Dimensions in millimetres

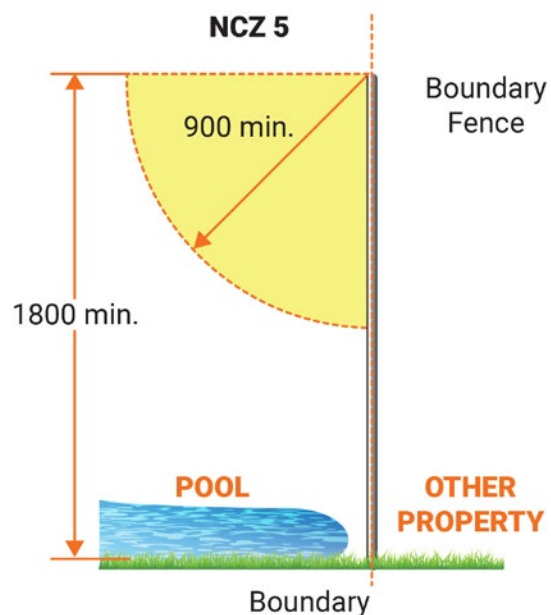

Section 3: Safety barrier requirements

Intersections with internal safety barriers

A safety barrier is permitted to intersect the NCZ 5 of the boundary barrier. However:

- if the top of the internal safety barrier is wider than 50mm, the internal safety barrier must be at least 1.8m high within the NCZ 5 area (see Diagram 13); and
- if the top of the internal safety barrier is 50mm wide or less, the internal safety barrier must be located between an angle of 45 and 135 degrees to the boundary barrier (see Diagram 14).

Diagram 13

Dimensions in millimetres

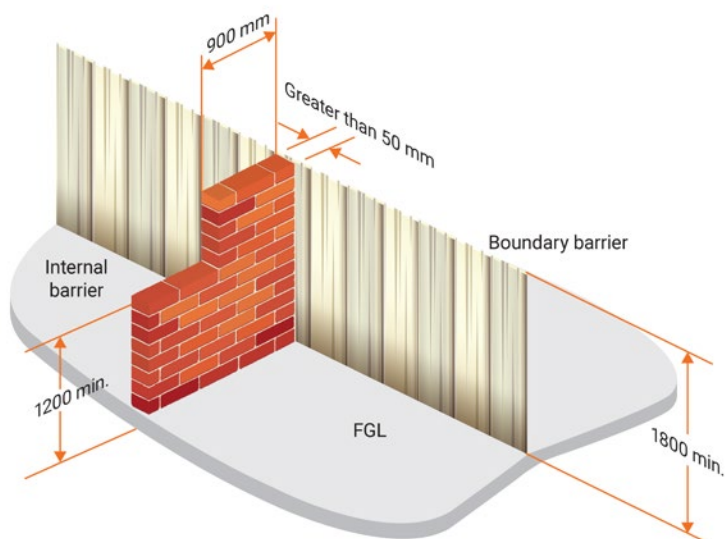
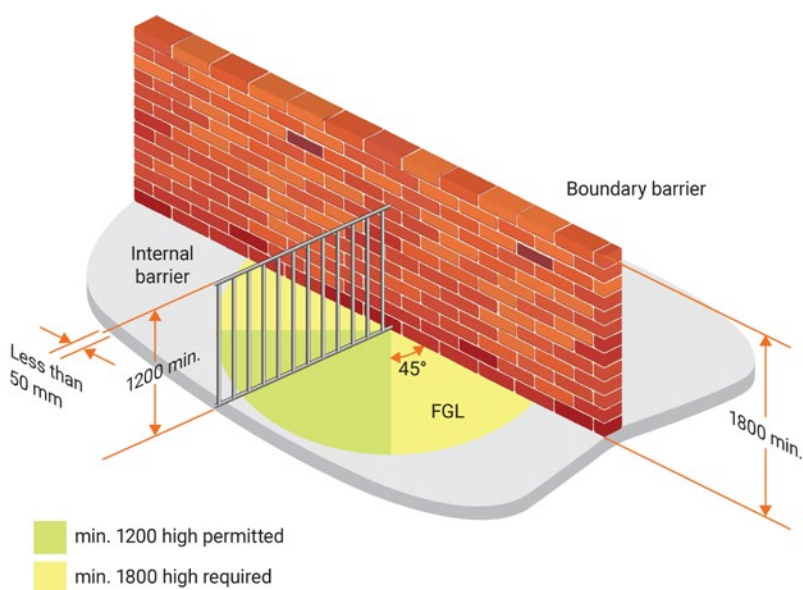

Diagram 14

Dimensions in millimetres



- min. 1200 high permitted
- min. 1800 high required

### Boundary barriers – Non-poolside option

The boundary barrier must be at least 1.2m high on the non-poolside.

There must be no objects, steps, retaining walls or ground level changes that reduce the 1.2m minimum height requirement within 500mm of the boundary barrier on the non-poolside.

NCZs 1, 2, 3 and 4 apply.

Diagram 15

Dimensions in millimetres

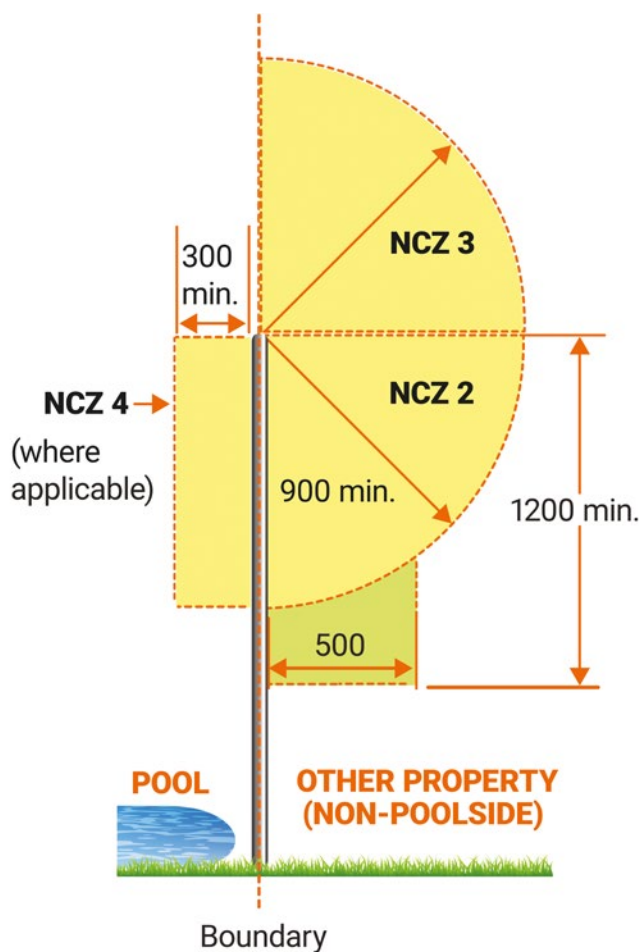

### Caution:

The non-poolside option relies on the adjoining property side of the fence, which is not typically within the control of the owner of the swimming or spa pool. The height, 500mm clear area, and NCZ 1, 2 and 3 are required to comply on the non-poolside and as such compliance may be difficult to achieve and maintain.

The non-poolside option is better suited to boundary barriers that abut the verge, parks, public land, or where the pool is on the high side of a significant retaining wall, or similar circumstances, where the owner has more control and/or where compliance can be more easily maintained.

Where the non-poolside option does not comply for whatever reason, at any time, the poolside option must be implemented immediately.

### Important:

Many local governments have fencing local laws/planning policies which include minimum height requirements for boundary/dividing fences that must also be complied with. Contact your local government for advice.

- Nothing that will facilitate climbing.
- No steps, retaining walls, objects or level changes that reduce the height of the barrier.

Section 3: Safety barrier requirements

**Boundary barriers – pre-May 2016 swimming or spa pools**

This section provides an alternative to the “Boundary barriers” requirements described in the preceding pages and is only applicable to swimming or spa pools applied for, or installed, prior to 1 May 2016.

Boundary barriers must:

- Have a height of at least 1.2m.
- Have its highest lower foothold at least 1100mm below the top of the boundary barrier.
- Have its highest lower foothold at least 900mm below its lowest higher handhold.
- Have no objects or surfaces that may facilitate climbing within a 1200mm span from the boundary barrier, measured as a lower quadrant.

The above applies to the non-poolside of the boundary barrier. Where, for any reason, the non-poolside of the boundary barrier does not comply with these requirements, the requirements must apply to the poolside of the boundary barrier instead.

**Caution:**

Compliance on the non-poolside relies on the adjoining property side of the boundary barrier, which is not typically within the control of the owner of the swimming or spa pool, and as such may be difficult to achieve and maintain.

The use of the non-poolside of the boundary barrier is better suited where it abuts a verge, park, public land, or where the pool is on the high side of a significant retaining wall, or similar circumstances, where the owner has more control and/or where compliance can be more easily maintained.

**Important:**

Many local governments have fencing local laws/planning policies which include minimum height requirements for boundary/dividing fences that must also be complied with. Contact your local government for advice.

Diagram 16

Dimensions in millimetres

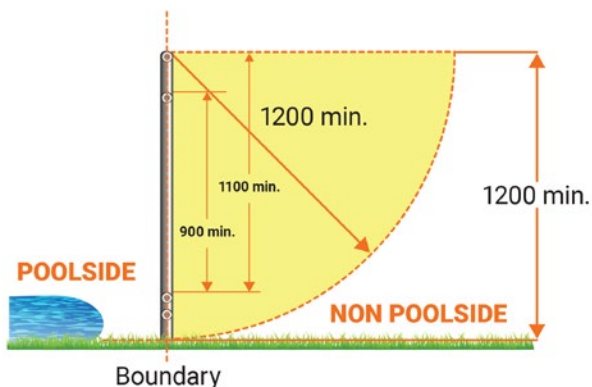
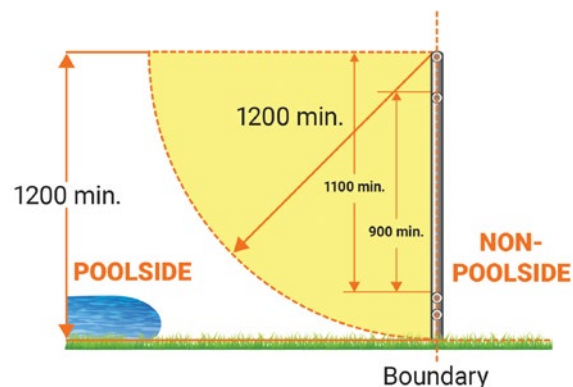

Diagram 17

Dimensions in millimetres





### Retaining walls

Retaining walls may form part of a safety barrier (see Diagrams 18 and 19), including a boundary barrier.

Where a retaining wall is used as a boundary barrier it must comply with one of the boundary barrier options.

If the retaining wall does not meet the below requirements, it cannot be used as part of the safety barrier and an alternative safety barrier must be provided.

#### Above the pool

A retaining wall located above the level of the swimming or spa pool can be used as part of the safety barrier if:

- it does not slope away from the swimming or spa pool by more than 15 degrees to the vertical; and
- it has a height of at least 1.8m on the poolside.

If the retaining wall is less than 1.8m it cannot be used and an alternative compliant pool barrier must be provided.

#### Below the pool

A retaining wall located below the level of the swimming or spa pool can be used as part of the safety barrier if:

- it does not slope towards the swimming or spa pool by more than 15 degrees to the vertical; and
- either:
  - it has a minimum height of 1.2m on the non-poolside and has no climbable surfaces that will facilitate climbing within NCZ 1, 2, 3; or
  - it has a height of at least 1.8m on the non-poolside.

Diagram 18

Dimensions in millimetres

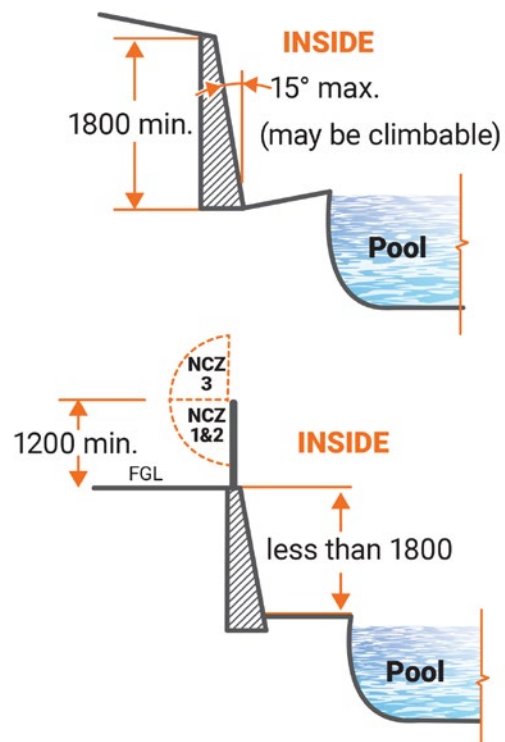
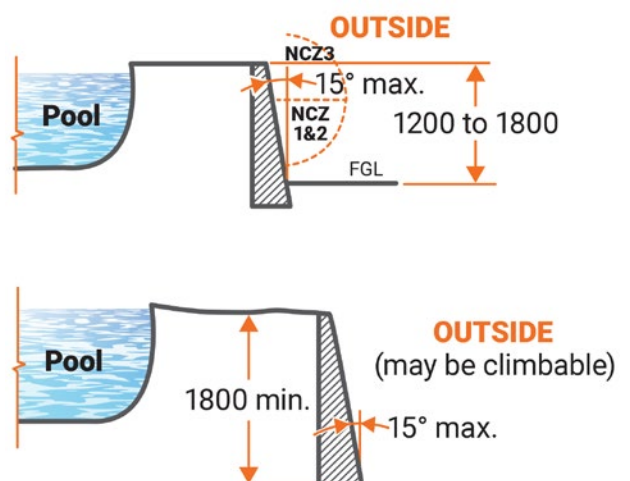

Diagram 19

Dimensions in millimetres



**Section 3: Safety barrier requirements**

There must be no steps, retaining walls, objects or level changes that would otherwise reduce the minimum height of the wall within 500mm of the wall.

Where a safety barrier above the retaining wall intersects with the retaining wall, the safety barrier must either extend past the outer edge by 900mm or extend to the edge of the retaining wall and return 900mm along the retaining wall in either direction. The outside surface of the safety barrier must be flush against the face of the retaining wall.

**Diagram 20**

Dimensions in millimetres

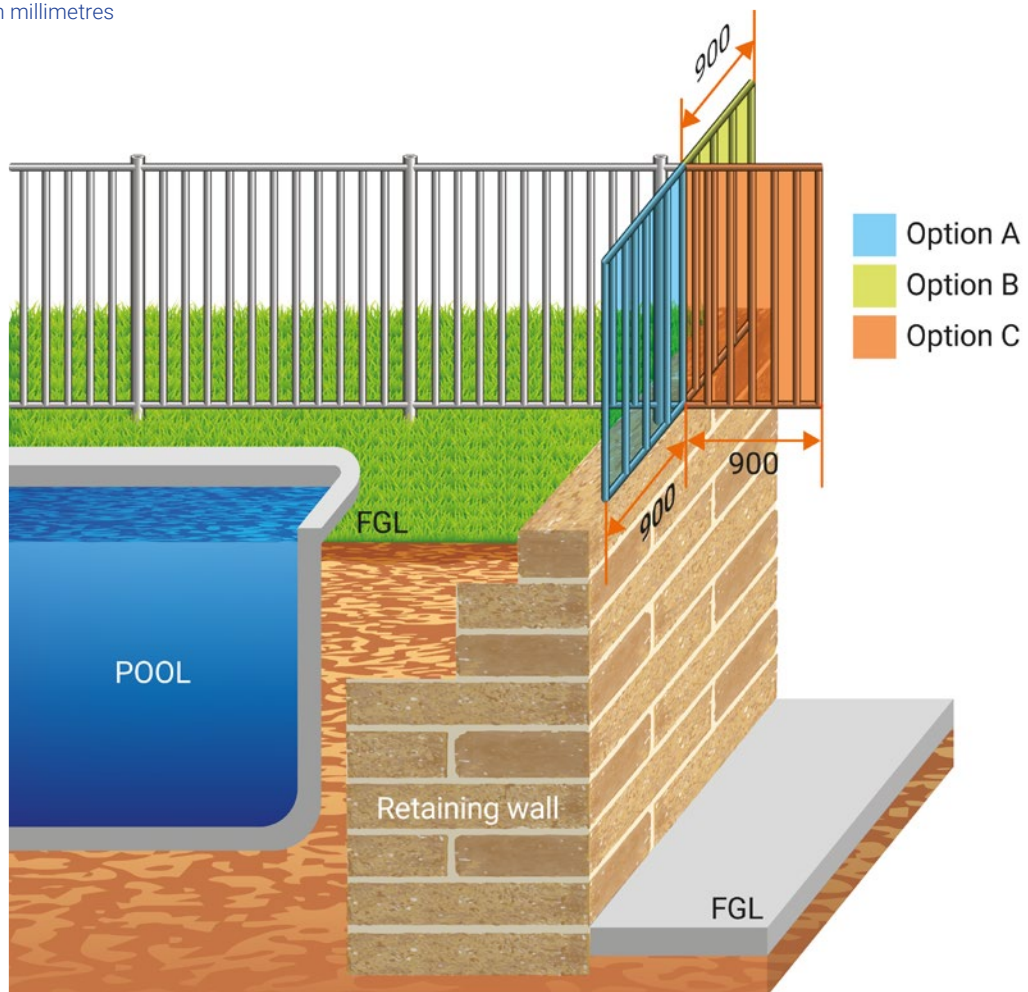

## Gates

**Gates are known to be the most common point of access for young children who have fatally drowned in swimming pools.**

Gates are also the most common area of non-compliance identified by safety barrier inspectors. Owners and occupiers need to be vigilant in ensuring their gates are compliant and well maintained at all times.

It is suggested that, where possible, gate posts share a single (monolithic) footing. This helps prevent the posts from moving independently which can cause future problems with gate latch alignment and latching.

### Diagram 21

Dimensions in millimetres

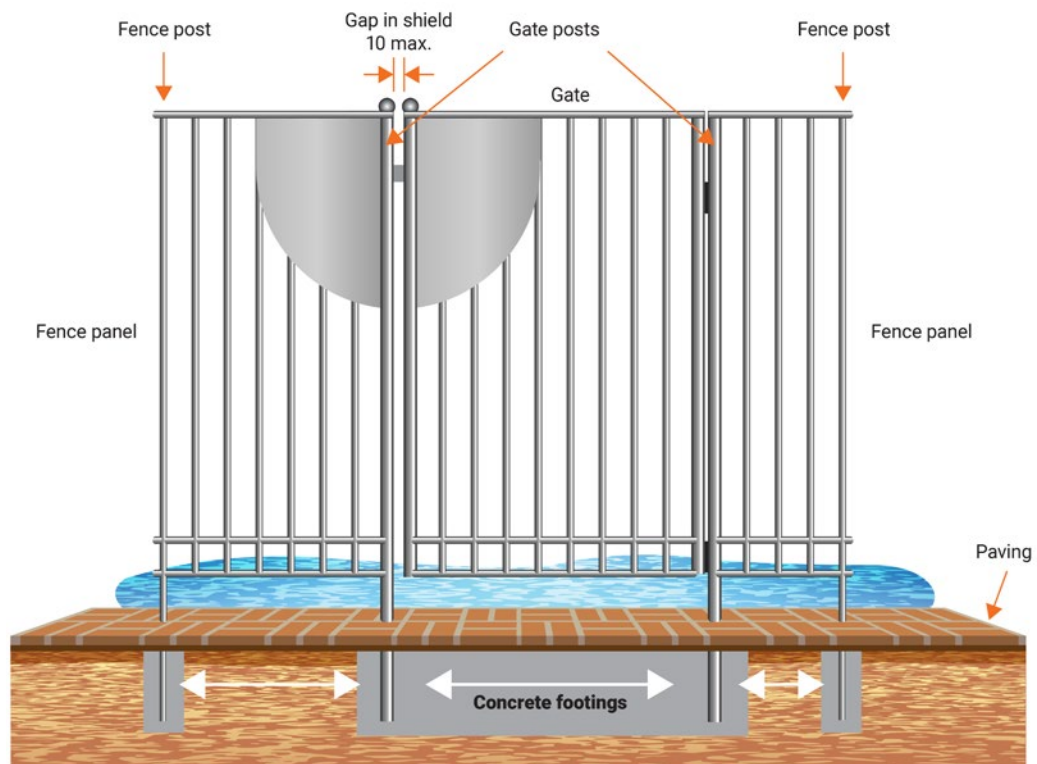

### Section 3: Safety barrier requirements

#### Direction of opening

Gates must swing outwards, away from the swimming or spa pool area. Gates are **not** permitted to slide sideways or open inwards towards the swimming or spa pool area.

Gates are **not** permitted to open into buildings or doorways.

#### Automatic self-closing device

Gates must self-close when released from any open position. Self-closing hinges are often used for this function.

All gates must be fitted with a device that will return the gate to the closed position without the use of manual force. The self-closing function must operate from any position that the gate is capable of opening to, from fully open to resting on the latch. The self-closing function must not allow the gate to inadvertently bounce back open.

Gates must be able to swing freely through their arc of operation.

Care should be taken when selecting the type and location of the gate as wind can cause it to delay or prevent the self-closing operation of the gate.

Some types of gates may be more affected by wind than others. Open style gates allow wind to pass through them, while solid type gates do not. Light materials such as aluminium may also be more affected by wind.

#### Gate clearance

The vertical gap beneath a gate is to be no more than 100mm. See Diagram 22.

The surface directly beneath the gate must be stable and not easily removed or eroded by weather, children or animals.

Suitable materials may include pavers, concrete, and decking. Grass is not recommended under the gate as it can grow quickly and may interfere with the self-closing functionality of the gate.

#### Diagram 22

Dimensions in millimetres

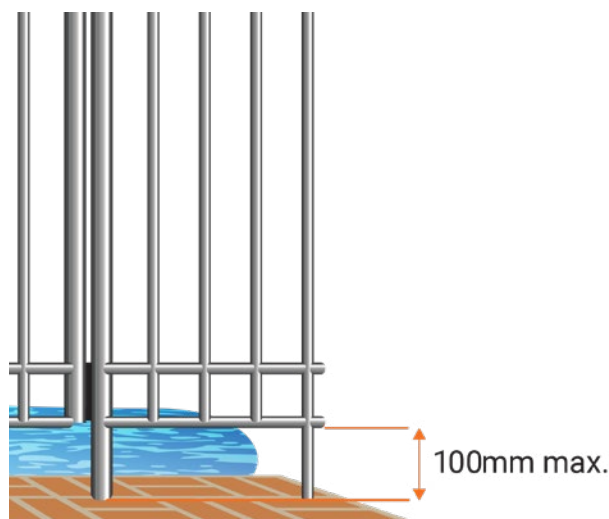

### Gate hinges

Hinges often have projections that exceed 10mm and as such may facilitate climbing. Where hinges do project more than 10mm from the gate, they must be spaced apart to ensure that any handholds or footholds are not located within NCZ 1 or 2.

Typically, the handhold or foothold provided by a gate hinge is the upper most surface of the hinge. However, this is not always the case, sometimes other components within the hinge, including upper and lower horizontal flanges, can form a handhold or foothold.

Where indentations and projections are sloped at 60 degrees to the horizontal, they are generally not considered to be handholds or footholds and are permitted to be within NCZs. However, some gate hinges, even though they may have a 60-degree top surface, have additional adjoining horizontal surfaces that exceed 10mm and as such those surfaces are not permitted to be within NCZs.

It is strongly suggested that, regardless of indentations, projections and slope, the bottom of the top hinge be spaced at least 900mm from the top of the bottom hinge, outside of the NCZ 1 and 2.

Be aware that some angled hinge caps currently available on the market are not suitable for use within NCZs.

Diagram 23

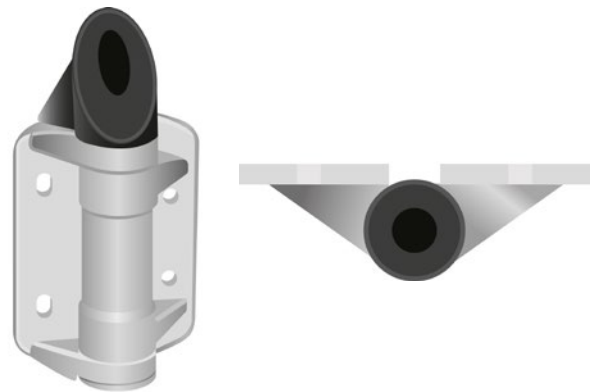
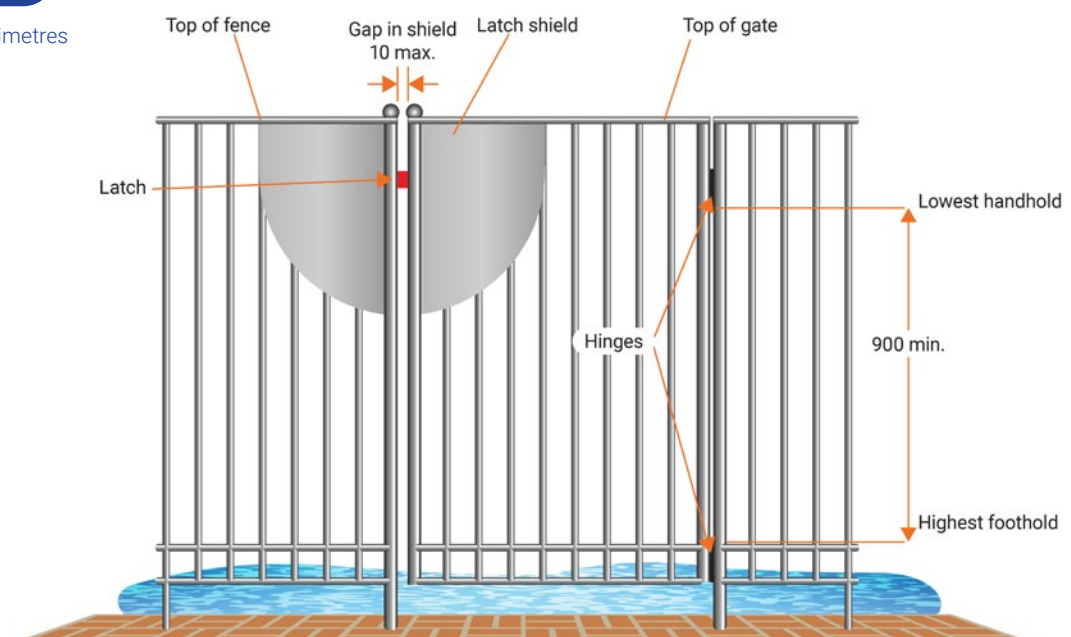

Diagram 24

Dimensions in millimetres



### Section 3: Safety barrier requirements

#### Latching device

The gate must have a latching device that will automatically secure the gate when closed without manual assistance. The latching device must not allow the gate to re-open without the proper use of the latch.

There are two options for the location of gate latch assemblies:

#### Option 1

- The latch release must be located at least 1500mm above the finished ground level when measured on the non-poolside of the safety barrier (see Diagram 25).

While not mandatory, it is suggested that the latch release be located at least 1400mm above the highest lower foothold (typically the top of the highest bottom horizontal rail) of the gate.

#### Option 2

The latch release must:

- be positioned on the poolside of the safety barrier;
- be positioned so that to reach the latch from the non-poolside it is necessary to reach over or through the safety barrier at a height of at least:
  - 1.2m above ground level; and
  - 1.0m above the highest of the low horizontal members;
- have shielding with a radius of at least 450mm from the latch release with no gaps that exceed 10mm (see Diagram 26);
- be at least 150mm below the top of the gate or the edge of the handhole (where applicable) (see Diagram 27); and
- not be able to be released by the insertion of an implement into or through the 10mm opening.

#### Diagram 25

Dimensions in millimetres

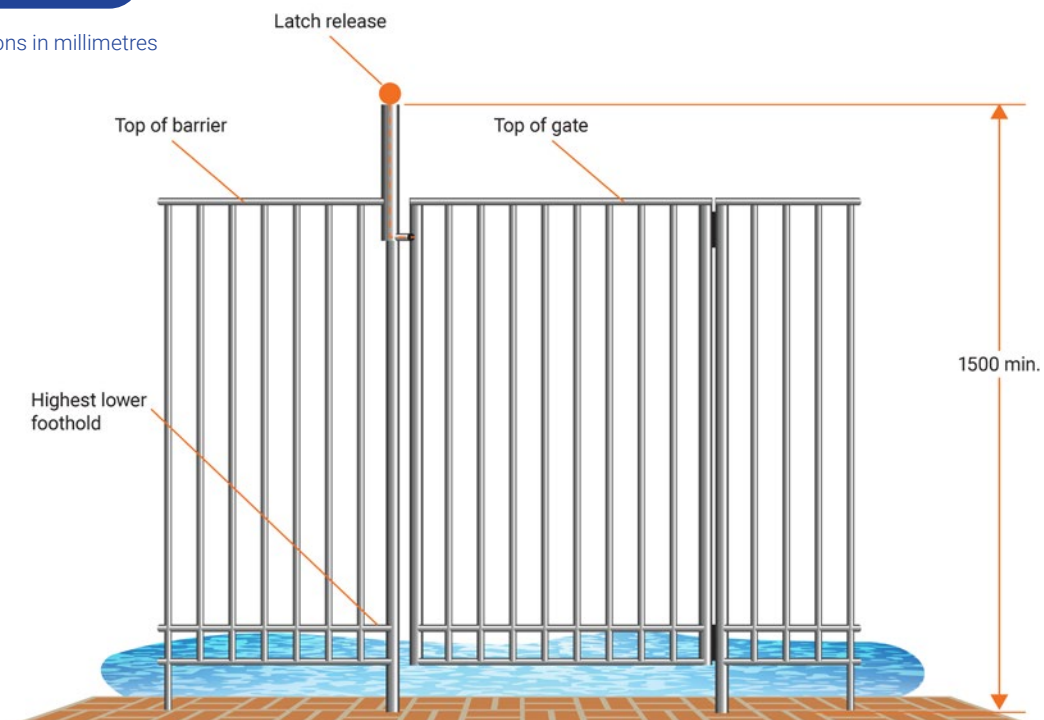

Diagram 26

Dimensions in millimetres

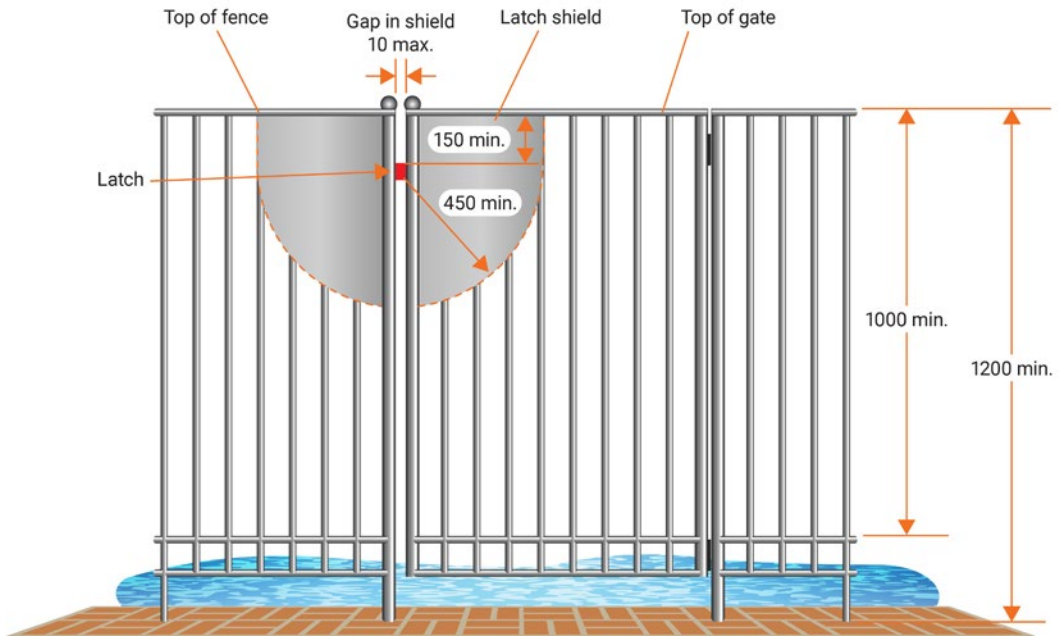
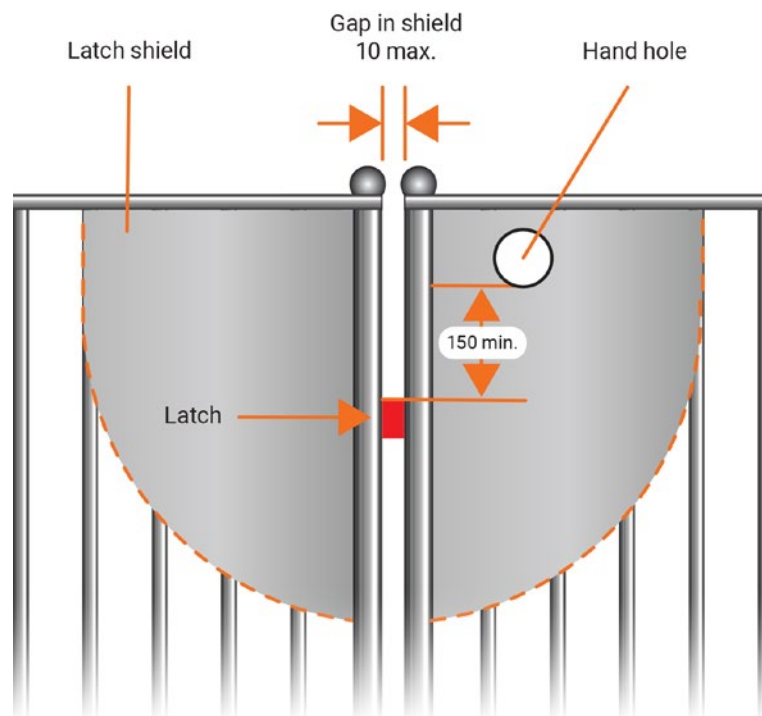

Diagram 27

Dimensions in millimetres



### Section 3: Safety barrier requirements

#### Above-ground swimming and spa pools

The side walls of an above-ground swimming or spa pool can be used as a safety barrier where:

- they are at least 1.2m high;
- there are no objects, steps, retaining walls or ground level changes that reduce the 1.2m minimum height requirement within 500mm; and
- NCZ 1, 2, and 3 comply.

Where a side wall has structural braces or other potentially climbable surfaces on the outside, it may not be able to be used as a safety barrier.

#### Steps and ladders

A safety barrier and gate must be built around permanently fixed steps or ladders and around a designated access point where steps or ladders are removable.

Reliance on the removal of ladders/steps after each use does not negate this requirement.

A lockable cover is not, and cannot be used instead of, a safety barrier.

Objects in and around the pool area are a constant problem for safety barrier compliance. Objects that may facilitate climbing should be securely stored away from the pool area.

All owners or occupiers with above-ground private swimming or spa pools are encouraged to install an appropriate safety barrier regardless of the design of the walls.

**Diagram 28**

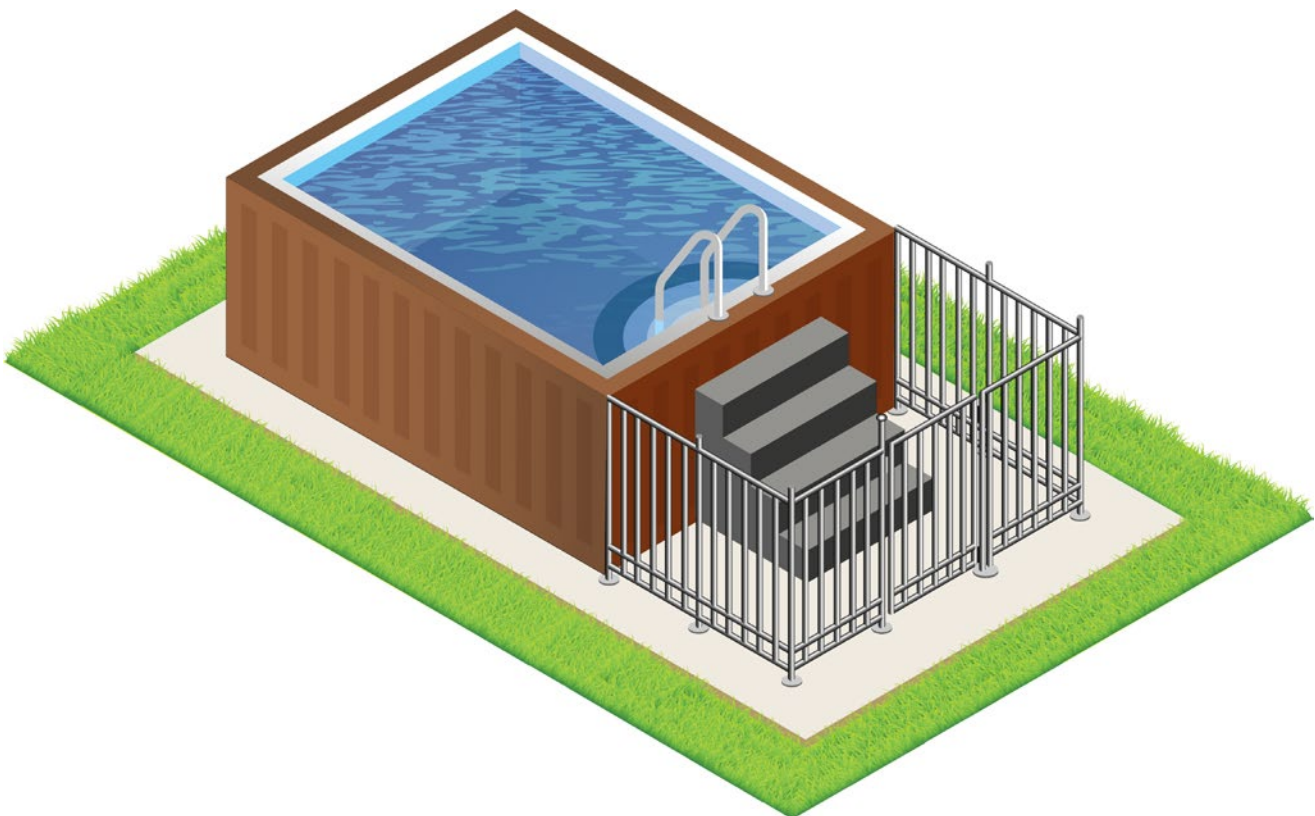



### Balconies

Where the floor level of a balcony is less than 1.8m to the finished ground surface below and it projects into a swimming or spa pool area, a safety barrier must be provided on the balcony. This may be achieved by ensuring that the balcony balustrade also complies with the safety barrier requirements.

Diagram 29

Dimensions in millimetres

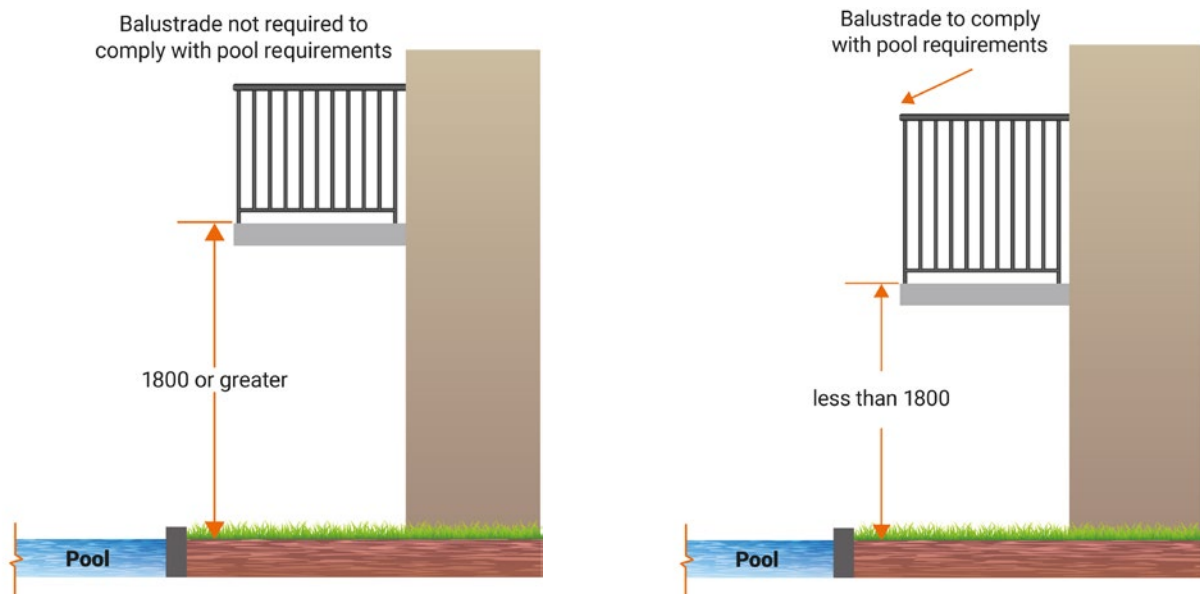
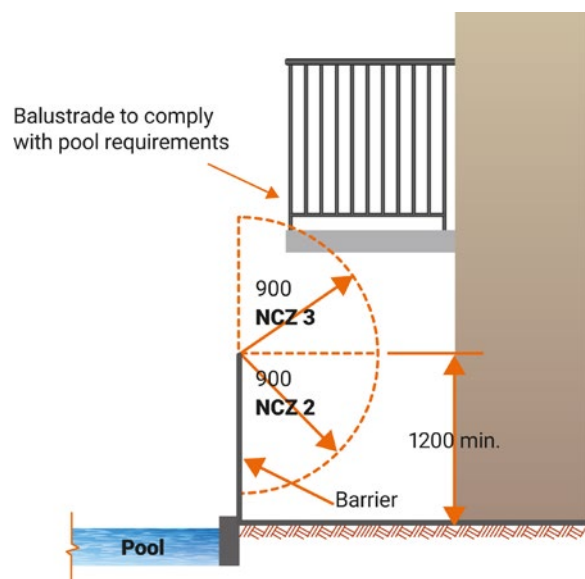

Diagram 30

Dimensions in millimetres

Where a safety barrier is located between the swimming or spa pool and a balcony, if the balcony projects into one of the safety barrier's NCZs, the balcony's balustrade must comply with the safety barrier requirements.



**Section 3: Safety barrier requirements**

**Openable portions of windows**

Where a window forms part of a safety barrier and it has a sill height on the poolside of less than 1.8m, the openable portion of the window must be restricted by either:

- a metal security screen, with maximum horizontal gaps of 100mm, that is secured to the building with fixings that cannot be removed without the use of a tool; or
- a device that limits the opening of the window to no more than 100mm.

Restricting devices must be permanent fixtures that require the use of a tool to remove (such as an Allen key, spanner, or screwdriver). Key locking devices are not acceptable.

Where windows form part of a safety barrier, it is suggested that owners consider upgrading the glazing to Grade-A safety glass to manage the risk of human impact.

**Diagram 31**

Dimensions in millimetres

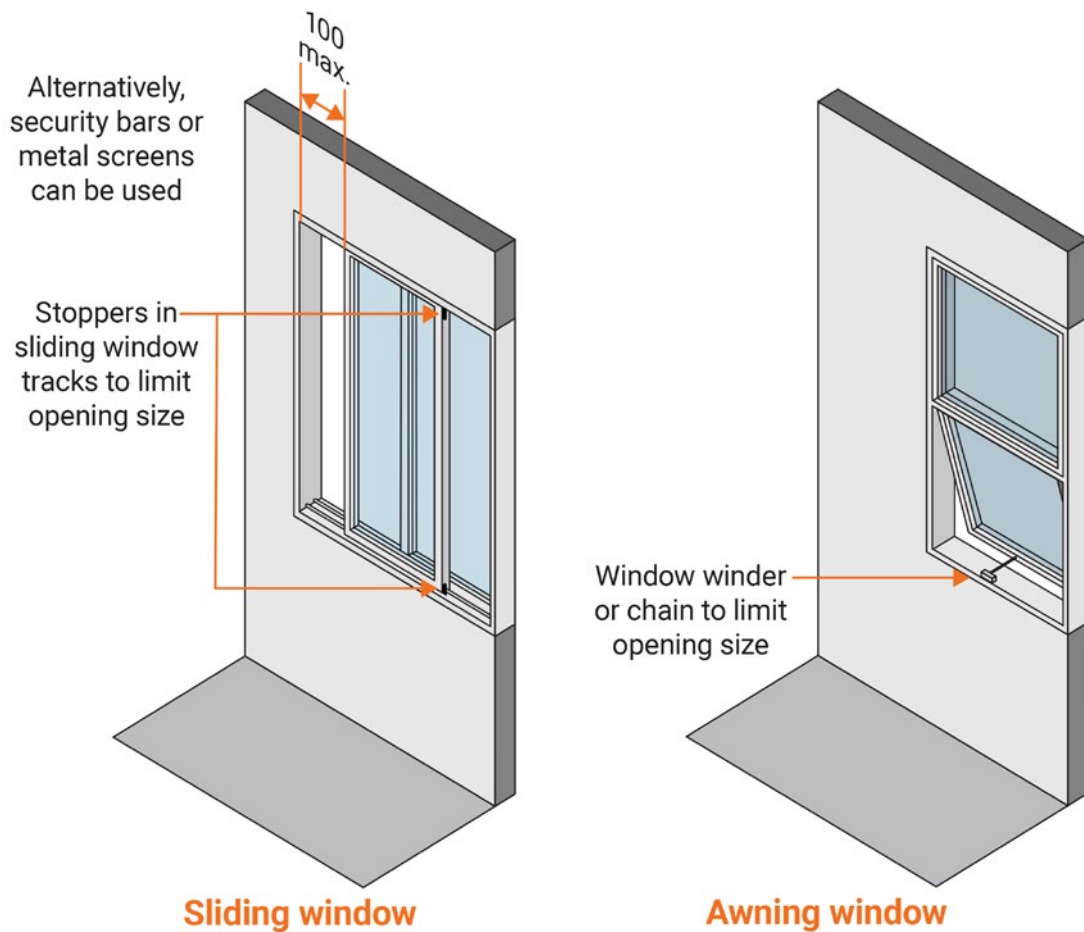

### Openable portions of windows – pre-May 2016 swimming or spa pools

This section provides an alternative to the “Openable portions of windows” requirements described in the preceding page and is only applicable to swimming or spa pools applied for, or installed, prior to 1 May 2016.

Where a window forms part of a safety barrier and it has a sill height on the poolside of less than 2.4m, the openable portion of the window must be restricted. The necessary restrictions depend upon the sill height of the openable portion of the window when measured from the non-poolside (typically inside the building).

- a) Sill height of 900mm or less:
- a metal security screen, with maximum horizontal gaps of 100mm, that is secured to the building with fixings that cannot be removed without the use of a tool; or
  - a device that limits the opening of the window to no more than 100mm.

Restricting devices must be permanent fixtures that require the use of a tool to remove (such as an Allen key, spanner, or screwdriver). Key locking devices are not acceptable.

- b) Sill height between 900mm and 1200mm:

- Comply with either the requirements described in (a) or be fitted with a securely fixed fly screen frame that has a fly screen material securely fixed to it and is in good condition. The screen fitted to the frame must be either powder coated aluminium or stainless steel. Nylon based fly wire is not of acceptable strength.

While openable portions of windows with a sill height of greater than 1200mm do not require restriction, it is recommended that the options described in (a) or (b) be considered.

Many objects within a room can provide a young child with a hand or foothold potentially facilitating access to the swimming or spa pool area through the openable portion of the window.

### Section 3: Safety barrier requirements

#### Child-resistant doors

A child-resistant door is only permitted to be used where it forms part of the safety barrier for an indoor swimming or spa pool, or for the indoor portion of an indoor/outdoor swimming or spa pool. The use of a child-resistant door in other situations is only permitted where the local government has specifically approved its use (typically as part of a performance solution).

Where permitted to be used, child-resistant doors that form part of the safety barrier must:

- be fitted with a self-closing device that will automatically return the door to the closed position when released from any open position, including when resting on the latch;
- be fitted with a self-latching device that will prevent the door from being re-opened without the operation of the latch release mechanism;
- have the operating part of the latch release mechanism at least 1500mm above the floor;
- not contain indentations or projections of more than 10mm on the door or its frame for 900mm vertically (NCZ 1) within the bottom 1.2m of the door, on the non-poolside of the door; and
- not open towards the pool area. Doors must either slide sideways or open outwards, swinging away from the pool area.

Where double doors or French doors are used it is often very difficult to get both sides to self-close and self-latch. It is acceptable to permanently fix one side closed, using a device that cannot be undone by hand or key. Similarly, bi-fold doors are unlikely to meet the requirements.

Pet doors are not permitted within a safety barrier.

Owners and occupiers should be aware that young children are resourceful and capable of using a climbable object found within the house to reach up and release the latching mechanism of the door. Care should be taken to not leave objects lying around that a young child may be able to use.

#### Diagram 32

Dimensions in millimetres

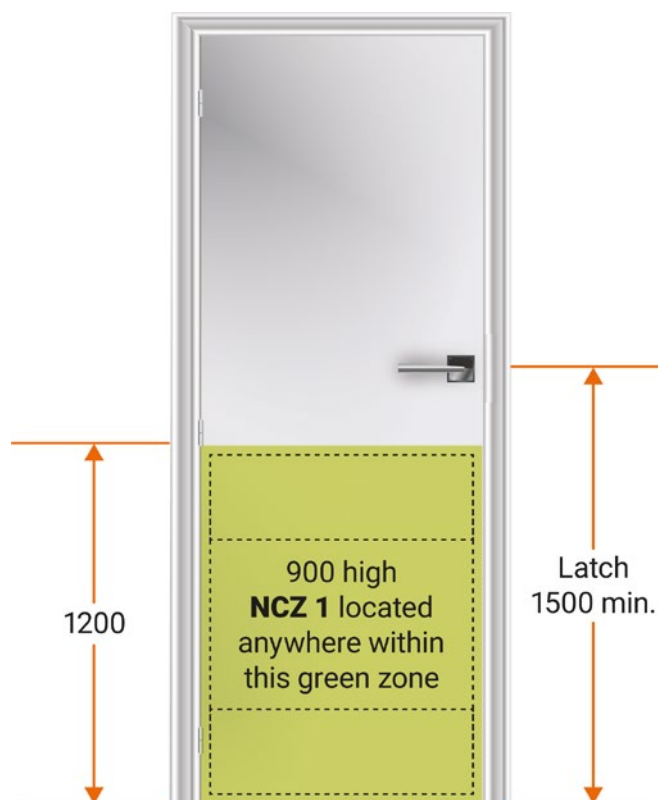

### Child-resistant doors – pre-November 2001 swimming or spa pools

This section provides an alternative to the “Child-resistant doors” requirements described in the preceding page and is only applicable to swimming or spa pools applied for, or installed, prior to 5 November 2001.

Pre-November 2001 swimming and spa pools are permitted to have child-resistant doors as part of their safety barrier where they comply with either the 1993 or 2012 edition of AS 1926.1.

### Garage doors

Garage doors, roller doors, and sliding gates, automatic or manually operated, are not covered by AS 1926.1 and are generally not permitted to form part of the safety barrier.

### Caution

While active adult supervision is the primary factor in preventing young children from drowning, safety barriers provide a valuable additional measure. However, some safety barriers are safer than others.

Child-resistant doors can be difficult to maintain and are one of the most common items identified as being non-compliant by local government pool inspectors. In general, child-resistant doors are not considered to be as safe as isolation fencing.

It is suggested that wherever possible child-resistant doors should not be used as part of a safety barrier. Owners of existing swimming or spa pools that include child-resistant doors as part of their safety barrier are encouraged to consider alternatives.

Owners of pre-November 2001 swimming or spa pools that use child-resistant doors can continue to use them, however, should be cautious due to the additional risk in doing so.

## Section 4: Additional considerations

### Supervision and maintenance

Supervision is the most effective way of preventing young children from drowning in private swimming or spa pools. Young children known to be in or around a swimming or spa pool area should always be actively supervised and their access to the swimming or spa pool area restricted.

For young children, adults should actively supervise within arm's reach. This means that, in most instances, the adult needs to be in the water with the child. Active supervision requires the responsible adult to ensure their complete attention is always focused solely on any child in or around the swimming or spa pool area.

Adults should take steps to minimise distractions, such as mobile phones or chatting to other parents, to avoid lapses in supervision. Supervising adults should not be multitasking.

Supervising adults should ensure they have everything they need before they let young children into the swimming or spa pool area, to prevent them having to leave them unsupervised. This should include towels, goggles, toys, dry clothes, snacks, and drinks. It is also a good idea to ensure young children have been to the toilet before they enter the swimming or spa pool area. Once the supervising adult is in the swimming or spa pool area, they should not leave a young child unattended, even for a short period of time.

Older children should not be relied upon to supervise young children. Older children are not equipped with the skills to perceive and respond to an emergency as well as adults and should not be given this responsibility. Parents leaving young children in the care of older siblings has been a factor in a number of drowning deaths.

The effectiveness of drowning prevention strategies, including safety barriers, relies upon adult supervision. Safety barriers are designed to be child-resistant, not child proof. A young child playing outside the swimming or spa pool area may find a way past the safety barrier, so adults need to supervise and never wholly rely on the safety barrier.

The effectiveness of safety barriers relies upon compliance and maintenance to ensure the barrier is effective at all times.

Remember:

- Never prop open the gate or child-resistant door. Keeping them closed will help prevent young children from drowning while a gate or door that is propped open will not.
- Keep the immediate surrounds clear of any objects. Young children can use objects to help them climb over the safety barrier and/or unlatch the gate.
- Maintain the pool gate. Regularly check the gate to ensure it is self-closing and self-latching and in good working order.

## CPR signs

Cardiopulmonary resuscitation (CPR) is a first aid technique that uses chest compressions and mouth-to-mouth to help someone who is not breathing or whose heart has stopped beating. It circulates oxygen throughout the body, keeping vital organs functioning until professional help arrives.

If a drowning incident occurs, the early application of CPR can significantly improve the chance of survival.

CPR signs are not mandatory for swimming and spa pools. However, having one permanently fixed near the pool could help save the life of a family member or friend by:

- providing an instructional reminder of the steps necessary to perform CPR;
- encouraging bystander participation and help prompt a person into action;
- being a constant reminder of the risks of drowning; and
- encouraging active supervision and safety barrier compliance to help prevent drowning incidents in the first place.

## Installation considerations

- Try to locate the CPR sign in a prominent position, preferably within three metres of the pool/spa.
- It should be visible from the shallow end of the pool and generally easy to read.
- Install it near the gate.
- Consider a position that protects the sign from the direct glare of the sun and other weather conditions that can cause it to deteriorate.
- Do not install it where it can be used to climb over and into the pool area, and not on a movable object.

Owners of swimming and spa pools are strongly encouraged to install a CPR sign.

Diagram 33

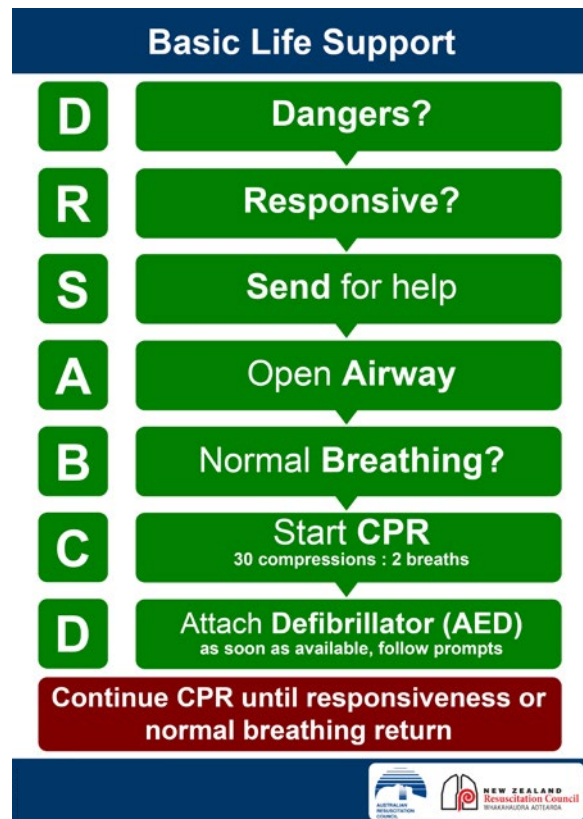

## **Section 4: Additional considerations**

### **Alarms**

An alarm can provide an audio or visual alert that someone may have entered the swimming or spa pool area. The use of an alarm is not mandatory and does not form part of the safety barrier requirements.

Alarms can provide an additional layer of protection and may be beneficial in some circumstances, however, alarms are not infallible and should not be wholly relied upon.

There are numerous types of alarms available, including:

- **Immersion alarms:** Usually consist of a central unit and a wearable item for a young child, such as a wrist band. The alarm sounds at the central unit when the wearable item is submerged in water.
- **Surface alarms:** Usually consist of a central unit and a sensor that floats on the water. The alarm sounds when waves are detected by the sensor.
- **Subsurface alarms:** Usually consist of a central unit and a sensor that is submerged underwater. The alarm sounds when a certain water pressure change is detected.
- **Gate alarms:** A sensor and alarm attached to the gate or that is part of the latch assembly. The alarm sounds when the gate is opened without being disarmed first, or after a certain time of remaining open.

Alarms do not lessen the importance of adult supervision and well-maintained and compliant safety barriers.





## Section 5: Frequently asked questions

### Does my spa pool require a safety barrier?

Yes. A spa pool, whether portable or fixed, comes under the definition of a private swimming pool in the Regulations and must have a compliant safety barrier.

### Is a building permit required for a swimming or spa pool?

For all swimming and spa pools, a building permit is generally required before construction can commence.

Please contact your local government for advice.

### Is a building permit required for a pool fence?

Pool fences will generally not require a building permit. There are specific circumstances when they will, and these are listed on page 5.

Please contact your local government for specific advice on building permit requirements.

### What can be used as a safety barrier?

Safety barriers can be comprised of a fence (including a boundary fence), wall, gate, window, retaining wall, or other safety barrier, or a combination of them. Materials such as aluminium, steel, masonry, glass, fibre-cement, and even brushwood, can be used. However, all safety barriers must comply with the regulatory requirements. Evidence of compliance is typically required but may be difficult to provide for non-tested systems.

### Can I use my boundary/dividing fence as part of the safety barrier?

Yes, if it complies with either the poolside or non-poolside boundary barrier requirements. Pre-May 2016 swimming or spa pools have additional options. See pages 19–22.

### I have an old pre-May 2016 swimming pool, what does my existing safety barrier need to comply with?

The safety barrier can comply with either AS 1926.1-2012 and AS 1926.2-2007, or AS 1926.1-1993 as referenced by the Regulations.

This document provides general guidance on the application of AS 1926.1-2012 and AS 1926.2-2007, and the application of AS 1926.1-1993 (as an alternative compliance pathway) for pre-May 2016 and pre-November 2001 swimming or spa pools for components that would not otherwise comply with AS 1926.1-2012.

### Can I use a child-resistant door as part of a safety barrier?

Only under the following circumstances:

- If the door forms part of a safety barrier to an indoor pool, or the indoor portion of an indoor/outdoor pool. The door must comply with AS 1926.1-2012;
- If the pool is using the pre-November 2001 concession. The door must comply with AS 1926.1-1993; or
- If an approval under regulation 51 of the Regulations has been given by the local government (typically as part of a performance solution).

### I want to replace my existing pre-May 2016 pool with a new one. Can I continue to use my existing safety barrier?

If the existing safety barrier complies with the AS 1926.1-2012 and AS 1926.2-2007 as described in Section 3 of this document, the existing safety barrier can be used. However, if the safety barrier (or part thereof) relies on the pre-May 2016 or pre-November 2001 requirements, it (or the relevant part) will need to be replaced or modified to comply with the newer requirements.

## **Section 5: Frequently asked questions**

### **I want to replace the existing safety barrier to my pre-May 2016 pool. Can the new safety barrier comply with the pre-May 2016 requirements?**

Yes. The new safety barrier can comply with the pre-May 2016 requirements but will need to comply with the structural reliability and resistance requirements in the edition of the Building Code in effect at the time of:

- installation of the new safety barrier (where no building permit is required); or
- submission of the application for the building permit for the new safety barrier.

### **I have an existing swimming pool. Can I install a new spa-pool in the same area and use the same safety barrier?**

The swimming pool and the spa-pool must each comply with their individual safety barrier requirements based on when the building permit was applied for or otherwise when they were installed.

If the existing safety barrier complies with AS 1926.1-2012 and AS 1926.2-2007 as described in Section 3 of this document, the swimming pool and spa-pool can use the same safety barrier. However, if the safety barrier (or part thereof) relies on the pre-May 2016 or pre-November 2001 requirements:

- it (or the relevant part) will need to be replaced or modified to comply with the newer requirements; or
- the spa-pool will need a separate safety barrier that complies with the requirements for a new pool.

Alternatively, you could discuss the possibility of a performance solution with your local government.

### **Does my above-ground pool require a safety barrier?**

Yes. However, the walls of the above-ground pool may be used as part of the safety barrier if they comply with the technical requirements in this publication (see page 30).

### **Can I use a lockable hard cover as the safety barrier for my spa pool?**

No. Placing a cover, even if it is lockable, over a spa pool does not satisfy the prescriptive safety barrier requirements.

When the cover is off there is no barrier. Safety barriers are required to be permanent in nature, restricting access by young children to the swimming or spa pool area at all times.

### **Do I need to put a safety barrier around my fishpond?**

As fishponds are not used for swimming, wading, paddling or the like they are not required to have a compliant safety barrier. However, fishponds still pose a risk for young children, and it is suggested that owners/occupiers consider providing safety barriers, or other devices.

### **Does my toddler's small plastic wading pool need a safety barrier?**

A compliant safety barrier is required if the pool contains water that is more than 30cm deep. This applies to all swimming and spa pools including portable, temporary, and wading pools.

### **What are the requirements for empty pools?**

Pools with a depth of water of 30cm or less do not require safety barriers. However, empty swimming pools can easily be refilled with water, creating a significant drowning risk for young children if safety barriers have been removed or are not compliant.

Empty pools remain on the pool register and local governments will continue to monitor as part of their periodic safety barrier inspection program, ensuring they either remain empty or otherwise have compliant safety barriers. Where a safety barrier has been removed from an empty pool the local government may consider this a high risk and monitor at more frequent intervals.

Where an empty pool is proposed to be removed or decommissioned the owner should contact their local government for guidance on their options, local requirements and considerations.

Where an empty pool is proposed to be refilled, the owner should contact their local government to organise an inspection of the safety barrier.

### **Can I have plants near my safety barrier?**

Vegetation that is near the safety barrier must be maintained so that it does not adversely affect the compliance of the safety barrier.

Plants that do not act as a handhold or foothold are unlikely to be considered to facilitate climbing and are typically able to be located within a NCZ.

Plants that are not considered to be able to support the weight of a young child are typically permitted to be located within 500mm of a safety barrier.

### **Can I have a pet door within a pool safety barrier?**

Pet doors are not permitted within a safety barrier.

### **Should I contact my local government when I replace my safety barrier?**

Where an existing swimming or spa pool has had a replacement fence or safety barrier installed (including boundary fence), it is suggested that the property owner contact the local government to organise an inspection as soon as possible. The cost of these inspections is covered by the periodic inspection charge.

### **Will I be fined for non-compliance?**

Local government inspectors undertake compliance inspections in accordance with their respective enforcement strategies which in some circumstances may result in a fine.

### **I'm going to buy/rent a house with an existing swimming pool. How do I know if the safety barrier is compliant?**

The local government can provide a copy of the most recent inspection certificate upon request to the owner or property manager. These are typically provided without cost as safety barriers are an important safety measure. However, certificates are reflective of compliance on the day of the inspection and there can be up to four years between inspections.

A non-mandatory inspection may be carried out by the local government or otherwise a suitably qualified and experienced person such as a building surveyor.

Remember, it is the owner and occupier who are jointly responsible for safety barrier compliance. It is reasonable to expect that, for leased properties, the owner is responsible for the provision and compliance of the safety barrier, and the occupier is responsible for ensuring the safety barrier remains compliant, for example, not propping the gate open, and general maintenance issues. Where a safety barrier is identified as being non-compliant by an occupier, they should report the matter to the owner/managing agent immediately, and temporarily make it safe themselves to the extent practicable.



## Section 6: Resources

### Pool and safety barrier guidance

**Building and Energy** [www.demirs.wa.gov.au/rules-for-pools](http://www.demirs.wa.gov.au/rules-for-pools)

### Product safety

**Consumer Protection** [www.demirs.wa.gov.au/consumerprotection](http://www.demirs.wa.gov.au/consumerprotection)

**ACCC Product Safety Australia** [www.productsafety.gov.au/products/pools-spas](http://www.productsafety.gov.au/products/pools-spas)

### Directory of local governments (permit authorities)

**WA Local Government Association** [www.walga.asn.au/about-local-government/online-local-government-directory.aspx](http://www.walga.asn.au/about-local-government/online-local-government-directory.aspx)

### Drowning prevention and water safety information

**Royal Life Saving Society WA** [www.royallifesavingwa.com.au](http://www.royallifesavingwa.com.au)

**Kidsafe** [www.kidsafe.com.au](http://www.kidsafe.com.au)

**Don't duck out/Make it safe  
(portable pool safety campaign)** [www.demirs.wa.gov.au/makeitsafe](http://www.demirs.wa.gov.au/makeitsafe)

**Australian Water Safety Council** [www.watersafety.com.au](http://www.watersafety.com.au)

### Pool industry information

**Swimming Pool and Spa Association** [www.spasa.com.au](http://www.spasa.com.au)

### Legislation

**Parliamentary Counsel's office** [www.legislation.wa.gov.au](http://www.legislation.wa.gov.au)

### Building Code of Australia

**Australian Building Codes Board** [www.abcb.gov.au](http://www.abcb.gov.au)

### Australian Standards

**Standards Australia** [www.standards.org.au/access-standards/buy-standards](http://www.standards.org.au/access-standards/buy-standards)

**State Library of Western Australia** [slwa.wa.gov.au](http://slwa.wa.gov.au)

The reserve section of the State Library of Western Australia provides limited, no-fee access to Australian Standards related to swimming pools and safety barriers.

**Reader Room** [readerroom.standards.org.au](http://readerroom.standards.org.au)

Reader Room is an initiative by Standards Australia which provides limited, no-fee access to many Australian Standards for non-commercial purposes.

## Appendix A: Building Code compliance

This Appendix is intended as general guidance for suppliers and installers of new safety barriers for private swimming and spa pools on compliance with the applicable building standards.

New safety barriers are required to comply with the applicable building standards as detailed in regulation 31C of the Building Regulations 2012.

Generally, new safety barriers should be designed and constructed to comply with the following Building Code performance requirements:

- “Structural reliability and resistance” from the edition of the Building Code in effect:
  - at the time of submission of the application for the building permit for the new safety barrier; or
  - at the time construction of the new safety barrier commenced (where a building permit is not required).
- “Swimming pool access” from any edition of the Building Code that was in effect:
  - at or after the time of submission of the application for the building permit for the swimming or spa pool; or
  - at or after the time construction of the swimming or spa pool commenced (where a building permit is not required).

The Building Code is a performance-based document. Compliance with the Building Code is achieved by satisfying the

performance requirements. This can be done by complying with:

- a deemed-to-satisfy solution;
- a performance solution; or
- a combination of both.

Section 3 of this document provides general guidance on the application of the Building Code deemed-to-satisfy pathway for the performance requirement “Swimming pool access” only (AS 1926.1-2012 and AS 1926.2-2007), and the application of AS 1926.1-1993 (as an alternative compliance pathway) for pre-May 2016 and pre-November 2001 swimming or spa pools for components that would not otherwise comply with AS 1926.1-2012. It does not provide guidance on the entirety of the applicable building standard and Building Code.

A performance solution for “Swimming pool access” must be approved by the permit authority before it can be used.

Information on the use of performance solutions is available from the [local government](#), the [ABCB](#), and [Building and Energy](#).

## Appendix B: Overview of responsibilities

This Appendix is intended as **general guidance** on compliance responsibilities under the building, and work health and safety, legislation.

Responsible person	Prior to and during construction, regardless of depth of water	On completion (typically handover) with > 30cm of water	After completion
PCBU <sup>1</sup>	✓ Manage health and safety risks <sup>2</sup>	✗	✗
Builder, as per building permit	✗	✓ Swimming/spa pool <sup>3</sup>	✗
		✓ Safety barrier <sup>3</sup>	
Owner, if no building permit	✗	✓ Swimming/spa pool <sup>3</sup>	✓ Safety barrier <sup>4</sup>
		✓ Safety barrier <sup>3</sup>	
Owner and occupier	✗	✓ Safety barrier <sup>4</sup>	✓ Safety barrier <sup>4</sup>

<sup>1</sup> Person Conducting a Business or Undertaking (generally the pool builder)

<sup>2</sup> *Work Health and Safety Act 2020*

<sup>3</sup> Compliance with the building permit and applicable building standards (s.29 & 37 *Building Act 2011* and r.31C *Building Regulations 2012*)

<sup>4</sup> Compliance with the specified building standards (r.50A *Building Regulations 2012*)

In general, and in simple terms:

- For the **swimming** or **spa pool**:
  - **applicable building standards** means:
    - the entirety of the edition of the Building Code that was in effect at the time of application for the building permit for the swimming or spa pool.
- For the **safety barrier**:
  - **applicable building standards** means:
    - the entirety of the edition of the Building Code in effect at the time the construction of the safety barrier commenced, except the performance requirement for "Swimming pool access"\* can be from any edition of the Building Code that was in effect at or after the time the construction of the swimming or spa pool commenced.
  - **specified building standards** means:
    - the performance requirement for "Swimming pool access"\* from any edition of the Building Code that was in effect at or after the time the construction of the swimming or spa pool commenced, for which guidance on the deemed-to-satisfy solution is provided in Section 3.

\* A performance solution must be approved by the permit authority before it can be used.

# Rules for **Pools** and **Spas**

A guide to the requirements  
for safety barriers in  
Western Australia

## **Department of Energy, Mines, Industry Regulation and Safety**

### **Building and Energy**

**Level 1, 303 Sevenoaks Street  
Cannington WA 6107**

Postal address:  
Locked Bag 14  
Cloisters Square WA 6850  
Phone: 1300 489 099  
Facsimile: (08) 6251 1501  
National Relay Service: 13 36 77

Website: [www.demirs.wa.gov.au/building-and-energy](http://www.demirs.wa.gov.au/building-and-energy)  
Email: [be.info@dmirs.wa.gov.au](mailto:be.info@dmirs.wa.gov.au)

Great Southern	(08) 9842 8366
South-West	(08) 9722 2888
Mid-West	(08) 9920 9800
Goldfields	(08) 9026 3250
North-West	(08) 9185 0900
Kimberley	(08) 9191 8400

This publication is available on request in other formats  
to assist people with special needs.

